



**TABLE OF CONTENTS**

---



**MASTER SPAS®**

6927 Lincoln Parkway • Fort Wayne IN 46804  
Phone: 260.436.9100 • Fax: 888-725-0694  
www.masterspas.com

Safety Instructions.....2-9

Operation Instructions..... 10

Overall Design Information..... 11-14

Typical Work Involved for Installation of Master Spas Spa..... 15-18

Installation Requirements..... 19-20

Typical Code Requirements ..... 21-28

Maintenance..... 29-38

    Water Chemistry Terms..... 29-30

    Basic Chemical Safety Guidelines ..... 31

    Water Quality Maintenance Start-Up..... 32

    Spa Water Maintenance/Start-Up ..... 33

    Spa Water Maintenance ..... 34

    Why Water Maintenance is Important..... 35

    Spa Water Maintenance Recommendations ..... 36

    Winterizing Your Spa..... 37

    Instructions for Multiple Day Periods of No Use of Spa ..... 38

Service Information / Trouble-Shooting Guide..... 39-40

    Propulsion System ..... 39-40

    Filtration..... 40

    Serviceable Components ..... 40

    Critical Replacement Components..... 40

    Warranty..... 41-43

    Contact Information ..... 43

Technical Drawings ..... 44-60

Pump Curves..... 61-62

Spa Care And Maintenance Record ..... 63-64

# SAVE THESE INSTRUCTIONS

Included with your new swim spa is a safety sign. The sign is for user protection and is suitable for outdoor use in wet locations. The sign should be placed in a location visible to all users of the spa.

Please take time to point out the physical location of the safety sign and the importance of the safety precautions displayed on the safety sign to all users. Remember, the safety of anyone who enjoys the use of the spa is our utmost concern.

The sign should be mounted with screws or another type of permanent fastener. Additional or replacement signs can be obtained from your dealer or direct from the factory.

## INTRODUCTION

It's time to relax! You now have your very own portable swim spa by Master Spas, Inc. By fully understanding the operation of each of the features of your new Swim Spa, you will be assured of many years of hassle-free, hot water therapy and fun.

Your safety is of paramount importance to the Master Spas family. We urge you to read and become thoroughly familiar with all safety aspects addressed in this manual.

Through reading and totally understanding the important information in your owner's manual, you will realize that you now own **THE ULTIMATE RELAXATION MACHINE!**

**NOTE:** Read, then keep these instructions for future reference.

<b>NO DIVING</b>	<b>DANGER: DIVING MAY RESULT IN SERIOUS INJURY OR DEATH.</b>	
------------------	--	---

## **IMPORTANT SAFETY INSTRUCTIONS**

When installing and using this electrical equipment, basic safety precautions should be observed including the following:

### **READ AND FOLLOW ALL INSTRUCTIONS**

**WARNING** – To reduce the risk of injury, do not permit children to use this product unless they are closely supervised at all times.

A wire conductor is provided on this unit to connect a minimum 6 AWG (13.302mm<sup>2</sup>) solid copper conductor between this unit and any metal equipment, metal enclosures of electrical equipment, metal water pipe, or conduit within 5 feet (1.5m) of the unit

(For cord-connected/convertible units)

**DANGER** – Risk of injury.

- a) Replace damaged cord immediately.
- b) Do not bury cord.
- c) Connect to a grounded, grounding type receptacle only.

(For units intended for indoor use only)

**WARNING** – For indoor use only. This unit is not intended for outdoor use.

(For units intended for outdoor use only)

**WARNING** – For outdoor use only. This unit is not intended for indoor use.

<b>NO DIVING</b>	<b>DANGER: DIVING MAY RESULT IN SERIOUS INJURY OR DEATH.</b>	
------------------	--	---

## **IMPORTANT SAFETY INSTRUCTIONS (CONT.)**

(For units with GFCI)

**WARNING** – This product is provided with a ground-fault circuit interrupter located on the front panel of selected swim spas. The GFCI must be tested before each use. With the product operating, open the service door. When the product stops operating, this merely indicates that the door is equipped with an electrical interlock. Next, push the test button on the GFCI and close the service door. The product should not operate. Now open the service door, push the reset button on the GFCI and close the service door. The product should now operate normally. When the product fails to operate in this manner, there is a ground current flowing indicating the possibility of an electric shock. Disconnect the power until the fault has been identified and corrected.

**DANGER** – Risk of Accidental Drowning. Extreme caution must be exercised to prevent unauthorized access by children. To avoid accidents, ensure that children cannot use this swim spa unless they are supervised at all times.

**DANGER** – Risk of Injury. The suction fittings in this swim spa are sized to match the specific water flow created by the pump. Should the need arise to replace the suction fittings or the pump, be sure that the flow rates are compatible.

Never operate swim spa if the suction fittings are broken or missing. Never replace a suction fitting with one rated less than the flow rate marked on the original suction fitting.

**DANGER** – Risk of Electric Shock. Install at least 5 feet (1.5m) from all metal surfaces. As an alternative, a swim spa may be installed within 5 feet of metal surfaces if each metal surface is permanently connected by a minimum 8AWG (8.4mm<sup>2</sup>) solid copper conductor to the wire connector on the terminal box that is provided for this purpose.

**DANGER** – Risk of Electric Shock. Do not permit any electric appliance, such as a light, telephone, radio, or television, within 5 feet (1.5 m) of a swim spa.

**WARNING** – To reduce the risk of injury:

- a) The water in a swim spa should never exceed 40°C (104°F). Water temperatures between 38°C (100°F) and 40°C are considered safe for a healthy adult. Lower water temperatures are recommended for young children and when swim spa use exceeds 10 minutes.

<b>NO DIVING</b>	<b>DANGER: DIVING MAY RESULT IN SERIOUS INJURY OR DEATH.</b>	
------------------	--	---

## **IMPORTANT SAFETY INSTRUCTIONS (CONT.)**

- b) Since excessive water temperatures have a high potential for causing fetal damage during the early months of pregnancy, pregnant or possibly pregnant women should limit swim spa water temperatures to 38°C (100°F).
- c) Before entering a swim spa, the user should measure the water temperature since the tolerance of water temperature- regulating devices varies.
- d) The use of alcohol, drugs, or medication before or during swim spa use may lead to unconsciousness with the possibility of drowning.
- e) Obese persons and persons with a history of heart disease, low or high blood pressure, circulatory system problems, or diabetes should consult a physician before using a swim spa.
- f) Persons using medication should consult a physician before using a swim spa since some medication may induce drowsiness while other medication may affect heart rate, blood pressure, and circulation.

(For swim spas with a gas heater)

**WARNING – Risk of Suffocation.** This swim spa is equipped with a gas heater and is intended for outdoor use only unless proper ventilation can be provided for an indoor installation.

### **HYPERTHERMIA**

Hyperthermia occurs when the internal temperature of the body reaches a level several degrees above the normal body temperature of 98.6° F.

THE SYMPTOMS OF HYPERTHERMIA INCLUDE:

- Dizziness • Fainting • Drowsiness • Lethargy
- Increase in Internal Body Temperature

THE EFFECTS OF HYPERTHERMIA INCLUDE:

- Unawareness of Impending Hazard • Failure to Perceive Heat • Failure to Recognize the Need to Exit Swim Spa • Physical Inability to Exit Swim Spa • Fetal Damage in Pregnant Women • Unconsciousness Resulting in a Danger of Drowning

<b>NO DIVING</b>	<b>DANGER: DIVING MAY RESULT IN SERIOUS INJURY OR DEATH.</b>	
------------------	--	---

## IMPORTANT SAFETY INSTRUCTIONS (CONT.)

**DANGER** – To reduce the risk of injury to persons, do not remove the suction grate. Suction through drains and skimmers is powerful when the jets in the swim spa are in use. Damaged covers can be hazardous to small children and adults with long hair. Should any part of the body be drawn into these fittings, turn off the swim spa immediately. As a precaution, long hair should not be allowed to float in the swim spa.

**WARNING** – Install the swim spa so that water can be easily drained out of the compartment containing electrical components so as not to damage equipment. When installing the swim spa make sure to allow for an adequate drainage system to deal with any overflow water. Please allow for at least 2 feet of clearance around the perimeter of the swim spa to provide enough room to access for servicing. Contact your local dealer for their specific requirements.

**WARNING** – The swim spa should be covered with an approved locking cover when not in use, to prevent unauthorized entry and injuries.

**WARNING** – People with infections, sores or the like should not use the swim spa. Warm and hot water temperatures may allow the growth of infectious bacteria if not properly disinfected.

**CAUTION** – Safe temperatures for swimming or aquatic exercise is around 80°F.

**CAUTION** – Risk of Electrical Shock. Do not leave CD compartment open. CD controls are not to be operated while inside the swim spa.

**CAUTION** – Replace components only with identical components.

**WARNING** – Risk of Electric Shock. Do not connect any auxiliary components (for example, additional speakers, headphones, additional audio/ video components etc.) to the system. These units are not provided with an outdoor antenna.

Do not service this product yourself as opening or removing covers may expose you to dangerous voltage or other hazards. Refer all servicing to qualified service personnel.

If the power supply cord(s) are damaged, water is entering the speaker, CD compartment, or any other component in the electrical equipment compartment area, the protective shield is showing signs of deterioration, or there are signs of other potentially hazardous damage to the unit, turn off the circuit breaker from the wall and refer servicing to qualified personnel.



<b>NO DIVING</b>	<b>DANGER: DIVING MAY RESULT IN SERIOUS INJURY OR DEATH.</b>	
------------------	--	---

## **IMPORTANT SAFETY INSTRUCTIONS (CONT.)**

The unit should be subjected to periodic routine maintenance once every quarter to make sure that the it is operating properly.

**DANGER – Risk of Electric Shock.** A green colored terminal or a terminal marked G, GR, Ground, Grounding or the symbol shown in Figure 14.1 of UL 1563 is located inside the supply terminal box or compartment. To reduce the risk of electric shock, this terminal must be connected to the grounding means provided in the electric supply service panel with a continuous copper wire equivalent in size to the circuit conductors supplying this equipment.

At least two lugs marked “Bonding Lugs” are provided on the external surface or on the inside of the supply terminal box or compartment. To reduce the risk of electric shock, connect the local common bonding grid in the area of the swim spa to these terminals with an insulated or bare copper conductor not smaller than 6AWG.

All field installed metal components such as rails, ladders, drains, or other similar hardware within 3m of the swim spa shall be bonded to the equipment grounding bus with copper conductors not smaller than 6AWG.

## **SAVE THESE INSTRUCTIONS**

## SAFETY INSTRUCTIONS

---

**WARNING:** CHILDREN SHOULD NOT USE SWIM SPAS OR HOT TUBS WITHOUT ADULT SUPERVISION

**AVERTISSEMENT:** NE PAS LAISSER LES ENFANTS UTILISER UNE CUVE DE RELAXATION SANS SURVEILLANCE

**WARNING:** DO NOT USE SWIM SPAS OR HOT TUBS UNLESS ALL SUCTION GUARDS ARE INSTALLED TO PREVENT BODY AND HAIR ENTRAPMENT.

**AVERTISSEMENT:** POUR ÉVITER QUE LES CHEVEUX OU UNE PARTIE DU CORPS PUISSENT ÊTRE ASIPIRES, NE PAS UTILISER UNE CUVE DE RELAXATION SI LES GRILLES DI PRISE D'ASPIRATION NE SONT PAS TOUTES EN PLACE

**WARNING:** PEOPLE USING MEDICATIONS AND/OR HAVING AN ADVERSE MEDICAL HISTORY SHOULD CONSULT A PHYSICIAN BEFORE USING A SWIM SPA OR HOT TUB.

**AVERTISSEMENT:** LES PERSONNES QUI PRENNENT DES MÉDICAMENTS OU ONT DES PROBLÈMES DE SANTÉ DEVRAIENT CONSULTER UN MÉDECIN AVANT D'UTILISER UNE CUVE DE RELAXATION

**WARNING:** PEOPLE WITH INFECTIOUS DISEASES SHOULD NOT USE A SWIM SPA OR HOT TUB

**AVERTISSEMENT:** LES PERSONNES ATTEINTES DE MALADIES INFECTIEUSES NE DEVRAIENT PAS UTILISER UNE CUVE DE RELAXATION

**WARNING:** TO AVOID INJURY EXERCISE CARE WHEN ENTERING OR EXITING THE SWIM SPA OR HOT TUB.

**AVERTISSEMENT:** POUR ÉVITER DES BLESSURES, USER DE PRUDENCE EN ENTRANT DANS UNE CUVE DE RELAXATION ET EN SORTANT

**WARNING:** DO NOT USE DRUGS OR ALCOHOL BEFORE OR DURING THE USE OF A SWIM SPA OR HOT TUB TO AVOID UNCONSCIOUSNESS AND POSSIBLE DROWNING

**AVERTISSEMENT:** POUR ÉVITER L'ÉVANOUISSEMENT ET LA NOYADE ÉVENTUELLE, NE PRENDE NI DROGUE NI ALCOOL AVANT D'UTILISER UNE CUVE DE RELAXATION NI QUAND ON S'Y TROUVE

**WARNING:** PREGNANT OR POSSIBLY PREGNANT WOMEN SHOULD CONSULT A PHYSICIAN BEFORE USING A SWIM SPA OR HOT TUB.

**AVERTISSEMENT:** LES FEMMES ENCEINTES, QUE LEUR GROSSESSE SOIT CONFIRMÉE OU NON, DEVRAIENT CONSULTER UN MÉDECIN AVANT D'UTILISER UNE CUVE DE RELAXATION

**WARNING:** WATER TEMPERATURE IN EXCESS OF 38°C MAY BE INJURIOUS TO YOUR HEALTH

**AVERTISSEMENT:** IL PEUT ÊTRE DANGEREUX POUR LA SANTÉ DE SE PLONGER DANS DE L'EAU A PLUS DE 38°C

**WARNING:** BEFORE ENTERING THE SWIM SPA OR HOT TUB MEASURE THE WATER TEMPERATURE WITH AN ACCURATE THERMOMETER

**AVERTISSEMENT:** AVANT D'UTILISER UNE CUVE DE RELAXATION MESURER LA TEMPÉRATURE DE L'EAU À L'AIDE D'UN THERMOMÈTRE PRÉCIS

## SAFETY INSTRUCTIONS

---

**WARNING:** DO NOT USE A SWIM SPA OR HOT TUB IMMEDIATELY FOLLOWING STRENUOUS EXERCISE

**AVERTISSEMENT:** NE PAS UTILISER UNE CUVE DE RELAXATION IMMÉDIATEMENT APRÈS UN EXERCICE FATIGANT

**WARNING:** PROLONGED IMMERSION IN A SWIM SPA OR HOT TUB MAY BE INJUROUS TO YOUR HEALTH

**AVERTISSEMENT:** L'UTILISATION PROLONGÉE D'UNE CUVE DE RELAXATION PEUT ÊTRE DANGEREUSE POUR LA SANTÉ

**WARNING:** DO NOT PERMIT ELECTRIC APPLIANCES (SUCH AS LIGHT, TELEPHONE, RADIO, OR TELEVISION) WITHIN 1.5 M OF THIS SWIM SPA OR HOT TUB

**AVERTISSEMENT:** NE PAS PLACER D'APPAREIL ÉLECTRIQUE (LUMINAIRE, TÉLÉPHONE, RADIO, TÉLÉVISEUR, ETC) À MOINS DE 1.5 M DE CETTE CUVE DE RELAXATION

**CAUTION:** MAINTAIN WATER CHEMISTRY IN ACCORDANCE WITH MANUFACTURER'S INSTRUCTION

**ATTENTION:** LA TENEUR DE L'EAU EN MATIÈRES DISSOUTES DOIT ÊTRE CONFORME AUX DIRECTIVES DU FABRICANT

Hyperthermia occurs when the internal temperature of the body reaches a level several degrees above the normal body temperature of 37°C. The symptoms of hyperthermia include drowsiness, lethargy, and an increase in the internal temperature of the body. The effects of hyperthermia include

- (a) unawareness of impending hazard;
- (b) failure to perceive heat;
- (c) failure to recognize the need to exit swim spa;
- (d) physical inability to exit swim spa;
- (e) fetal damage in pregnant women; and
- (f) unconsciousness and danger of drowning.

**WARNING:** THE USE OF ALCOHOL OR DRUGS CAN GREATLY INCREASE THE RISK OF FATAL HYPERTHERMIA IN HOT TUBS AND SWIM SPAS

LA CONSOMMATION D'ALCOOL OU DE DROGUE AUGMENTE CONSIDÉRABLEMENT LES RISQUES D'HYPERTHERMIE MORTELLE DANS UNE CUVE DE RELAXATION.

## OPERATION INSTRUCTIONS

---

The only user controllable components are jet pumps 1, 2, e-stop/timer, and the Wave propulsion system.

### E-STOP

The E-stop is installed to allow for quick power down should an emergency arise in or around the spa. Simply pressing the e-stop will cut power to the jet pumps, filter pump, and propulsion system until the e-stop is reset. The E-stop can be reset by twisting the button counter clockwise.

*\*Never use the e-stop as a maintenance system shutoff, or for any reason other than an emergency. Should the need to shut the unit down arise, the main input power breakers should be used as a means of completely disconnecting power.*

### Jet Pump 1, Jet Pump 2

These components are controlled by the e-stop and timer. To turn on, simply confirm that the e-stop button is not tripped, and then turn the timer to the desired time (15 minutes max). After 15 minutes, the jet pumps will automatically turn off.

### Light

Spa light shall be controllable from the equipment room only and shall not be accessible to occupants. Operation of lights shall be on continuously.

Exception: Should local authority having jurisdiction allowed for it, the light may be turned off during hours when spa is not open to the public.

### Wave Propulsion System

The Wave propulsion system works off of the control panel located on the end of the spa opposite of the entry steps (see figure 1). This panel is designed with simple operation in mind. The swim number system allows the user to easily identify what setting they are using during training. These numbers range from 0-60 so that a favorite setting can always be repeated easily. The Swim Number System allows the user to easily increase the speed of water flow by either gradually pressing the "SPEED UP/ON" button or by holding it down to achieve the desired Swim Number. To decrease the speed of the water flow press the "SPEED DOWN/OFF" button until the desired speed is reached. To completely turn off the system, press and hold the "SPEED DOWN/OFF" button for 7 seconds before releasing it. The system has an automatic shut-off feature that will turn off the propulsion system after 30 minutes of continuous use.



Figure 1

## OVERALL DESIGN INFORMATION

### Description of Spa / Exercise Spa

**NOTE.** Exercise/Swim Spa will be referred to as Spa in this manual. Spas and Exercise Spas are very similar as defined in ANSI/APSP Standards, and the ICC International Swimming Pool and Spa Code.

The Michael Phelps Signature Swim Spa is a high grade acrylic aquatic vessel with an underlying fiberglass reinforced shell, self contained frame, therapy jets and patented propulsion swim system. This spa may be installed completely in ground, partially in ground, or above ground level. The associated mechanical and electrical components are typically installed in a separate equipment room or in a lower level mechanical room below the floor surface.

**Since code and regulation requirements vary between states and local agencies, permits and compliance with varying health, electrical, plumbing, building, and safety, agencies is solely the responsibility of the owner. It is imperative that the owner or the design representative consult with all local and state regulatory agencies that have jurisdiction over installation of factory built commercial spas. Should any of these codes require that installation vary from the recommendations in this guide, contact Master Spas Inc. for assistance.**

Physical Specifications						
	Dimensions	Water Capacity	Weight Dry	Weight Wet	Min. Floor Support	Occupancy**
MP Rx 17 (8800)	201" x 94" x 51"*	2,000 gallons	2,700 lbs.	20,120 lbs.	3600 PSF (25 PSI)	4 (88.1 sq. ft.)
MP Rx 18 (9700)	215" x 94" x 60"*	2,200 gallons	3,240 lbs.	22,330 lbs.	3600 PSF (25 PSI)	4 (96.1 sq. ft.)
Optional Skid Pack	Width- 52.5" Depth- 25.5" Height- 42.5" Minimum service height - 59"					

\*Dimensions may vary as much as + - 1 inch based on manufacturing tolerances. For installations requiring an exact fit to the deck, it is recommended that the installer waits until the unit is positioned in its final resting spot, and filled before completing the joint where the deck meets the vessel.

\*\*Occupancy based on one bather for every 20 sq. ft. This is a general guideline and local jurisdiction regulation shall be considered. Occupancy weight based on 180 lbs.

Electrical Specifications					
	Voltage	Max. Current	Min. G.F.C.I. Breaker Size	Frequency/Phase	GFCI Required
Optional Filter Pump****	230V	SF 8.0A	15A	60Hz. Single Phase	Yes *
Optional Jet Pump 1****	230V	SF 11.2A	15A	60Hz. Single Phase	Yes *
Optional Jet Pump 2****	230V	SF 8.0A	15A	60Hz. Single Phase	Yes *
Propulsion**	240V	40A	50A	60Hz. Single Phase	Yes **
Optional Control Box***	240V	N/A	1x30, 1x15A, 1x50A	60Hz. Single Phase	Yes *

\* Customer Supplied \*\* Supplied by Master Spas, Inc.

\*\*\* When optional Control Box is used, only the Min. G.F.C.I. Breaker Size for "Optional Control Box" should be used. See wire diagram in back of manual for details.

\*\*\*\* Specifications based on recommended components.

## OVERALL DESIGN INFORMATION

Minimum Component Requirements (Installed components shall be NSF-50 certified for pool and spa use)		
Filter Pump*	Max. 1.5HP @ SF 1.10	Shall not exceed max. filter specification, or 251 GPM
Jet Pump 1*	Shall not exceed 251 GPM	Recommended 1.5 HP @ 1.10 SF
Jet Pump 2*	Shall not exceed 251 GPM	Recommended 2.0 HP @ 1.10 SF
Chlorinator	.5 lbs./day/1,000 gallons (level 3)	Local/State codes may vary
Filter	200 sq. ft.	

\*Installer shall confirm that the pumps are not capable of exceeding the maximum flow rate specified on the installed suction (251 GPM). This shall be confirmed by either using recommended components, or testing the system prior to completion of install.

All pumps and filtration systems components shall meet the requirements of: NSF/ANSI 50 and/or ANSI/UL 1081

Recommended Components		
Component	Description	Master Spas Part Number
Filter Pump	Waterway Champion 1.5 HP Pump	X320521
Jet Pump 1	Waterway Champion 2.0 HP Pump	X320522
Jet Pump 2	Waterway Champion 1.5 HP Pump	X320521
Chlorinator (level 3)	Waterway Clear Water Tablet Feeder	X268518
Filter	Waterway ProClean 200 SF Filter	X268516
Optional Skid Pack*	Complete Skid Pack w/all components	X620690

\*Skid pack comes with filter pump, jet pump 1, jet pump 2, chlorinator, filter, and plastic mounting plates.

Recommended components will satisfy the requirements of NSF-50 and most local and state codes. Should a local or state code require a more restrictive component, the local code shall take priority over these recommended components unless code presents an unsafe configuration such as a pump that exceeds the flow specifications of the installed suction.

### Line Voltage

The specified voltage within 10%± is required for proper operation of the propulsion GFCI and all connected equipment. Should an auto transformer (also known as a buck-boost transformer) be required, we recommend the following model:

Manufacturer: Dongan • Model: 80-M040 • Wire Configuration: See “Technical Drawings” section

### Serviceability and Equipment Access

The design information relating to structural, electrical, architectural, and plumbing design should be adhered to so as to insure serviceability of the spa in the future. Non compliance with these requirements could result in the warranty being voided.

### PREPARATION OF THE SPA SITE

The owner will be responsible for all site preparation before and after delivery of the spa. All utilities (water, sanitary, electrical, and etc.), mechanical pit, and applicable spa area structures must be designed and installed by the owner. For information concerning details of these requirements, consult the technical specifications included in this manual.

### SPECIFICATIONS FOR SPA ROOM AREA

If installed indoors, the recommendation for the area in which the spa is contained is at least 3 feet of separation between outer edge of spa and interior wall around perimeter and 8 feet high. This is to allow adequate room for installation and proper deck space in the spa area. Extra space for shower, storage cabinets, dehumidifiers, changing areas, and showers should be integrated into these plans. Room dimensions may vary depending on requirements of the local and state regulatory authority having jurisdiction.

Temperature control and proper air handling (which should include humidity control) in the spa room must be integrated into the room design to maintain a comfortable and safe environment for the room occupants. Spa rooms are normally kept at 85 degrees Fahrenheit and spa water temperatures are typically kept below 93 degrees Fahrenheit. This helps keep the differential between the spa and room temperatures to a minimum.

# OVERALL DESIGN INFORMATION

## SPECIFICATIONS FOR SPA ROOM AREA

Evaporation from spas located inside a temperature controlled room depends mainly on four factors.

- Water temperature
- Ambient air temperature
- Humidity in room
- Area of water surface

The charts below show the evaporation in gallons for a 24 hour period.

First, select the appropriate chart for your model spa. Choose the room temperature in the vertical column under "Air". Next, across the row titled "Water Temp F" select the temperature of the water. In the columns below the water temperature select the nearest common humidity level. Locate the intersection of the row and column you have selected to find the gallons of daily water evaporation from your spa. This amount of water will need to be replaced on a daily basis. *Note: Tables assume spa indoors and without cover.*

MP Rx 17: Evaporation Rate Gallons per Day												
Water Temp °F	84		86		88		90		102		104	
	50%	60%	50%	60%	50%	60%	50%	60%	50%	60%	50%	60%
72	13.25	11.91	14.54	13.2	15.96	14.62	17.43	16.09	28.17	26.83	30.3	28.96
74	12.77	11.35	14.09	12.64	15.48	14.06	16.98	15.53	27.69	26.25	29.85	28.4
76	12.29	10.74	13.58	12.06	15	13.45	16.47	14.95	27.21	25.67	29.34	27.79
78	11.76	10.11	13.05	11.43	14.47	12.82	15.94	14.31	26.68	25.03	28.81	27.16
80	11.2	9.45	12.52	10.74	13.91	12.16	15.38	13.63	26.12	24.37	28.25	26.5
82	10.62	8.741	12.01	10.03	13.33	11.45	14.8	12.92	25.54	23.66	27.67	25.79
84	9.982	7.981	11.3	9.298	12.69	10.69	14.16	12.19	24.91	22.9	27.03	25.06
86	9.324	7.195	10.64	8.513	12.03	9.906	13.5	11.38	24.25	22.12	26.37	24.25
88	8.868	6.359	10.19	7.652	11.58	9.07	13.07	10.54	23.79	21.28	25.94	23.41
90	7.88	5.473	9.197	6.79	10.59	8.184	12.09	9.653	22.8	20.4	24.96	22.52

MP Signature Rx 18: Evaporation Rate Gallons per Day												
Water Temp °F	84		86		88		90		102		104	
	50%	60%	50%	60%	50%	60%	50%	60%	50%	60%	50%	60%
72	14.45	12.99	15.86	14.4	17.41	15.95	19.01	17.55	30.73	29.27	33.05	31.59
74	13.93	12.38	15.37	13.79	16.89	15.34	18.52	16.94	30.21	28.63	32.56	30.98
76	13.4	11.72	14.81	13.16	16.36	14.68	17.96	16.31	29.68	28	32	30.32
78	12.82	11.03	14.23	12.46	15.78	13.98	17.38	15.61	29.1	27.31	31.42	29.63
80	12.22	10.31	13.65	11.72	15.17	13.27	16.78	14.87	28.49	26.59	30.81	28.91
82	11.58	9.535	13.1	10.94	14.54	12.49	16.14	14.09	27.86	25.81	30.18	28.13
84	10.89	8.706	12.33	10.14	13.85	11.66	15.45	13.29	27.17	24.98	29.49	27.33
86	10.17	7.849	11.61	9.286	13.13	10.81	14.73	12.41	26.45	24.13	28.77	26.45
88	9.673	6.937	11.11	8.346	12.63	9.894	14.26	11.5	25.95	23.21	28.3	25.54
90	8.595	5.97	10.03	7.407	11.55	8.927	13.18	10.53	24.87	22.25	27.22	24.57

## OVERALL DESIGN INFORMATION

---

### ADA COMPLIANT LIFT CHAIR

This spa shall be installed with an ADA Compliant lift chair and shall be installed in accordance with the manufacturers recommendations, and any local or state codes. Master Spas, Inc. does not supply an ADA lift chair, however we have tested and approved various models to work with our product. Below is a list of manufacturers and contact information which will allow the installer to obtain the appropriate lift chair for this installation:

Aqua Creek Products

Model: Pro Spa 60 / Master Spas

Toll Free: 888-687-3552 • Local: 406-549-0769 • Fax: 406-549-2602

[www.aquacreek.com](http://www.aquacreek.com) • [Sales@aquacreek.com](mailto:Sales@aquacreek.com)

*\*\*\* Note that for use with a spa larger than 54", the lift will need to be mounted 6" above the final level of the room floor where the spa is resting. Additionally, the area where the chair will be accessed from will need to be raised 6" to accommodate the chair entry requirements of ADA. If you are installing an Aqua Creek Pro Spa 60 on a spa taller than 54", please call our customer service department if you have any questions prior to installation or purchase of chair.*

Spectrum Aquatics

Model: Summit 500 BP / Master Spas

Toll Free :800-791-8056 • Local: 406-532-6321 • Fax: 800-791-8057

[www.spectrumproducts.com/](http://www.spectrumproducts.com/)

Specifications, dimensions, analysis, etc. can be obtained through the lift chair

### UTILITIES

**Water Supply:** The owner will need to provide a fresh water source to the spa room for replenishing the water in the spa.

**Sanitary:** A sump pit (if applicable) that includes a pump or floor drains that connect to the main drainage system must be provided by the owner.

**Gas:** The spa can be heated by a gas heater. When using any gas fired appliance care must be taken to provide adequate combustion air and also proper ventilation of flue gases. See appliance manufactures recommendations for information guidelines.

**Electrical Service:** Electrical service must be provided by the owner.

**Communications:** It is highly recommended that a telephone line be installed in the area of the control panel for communication in case of emergencies.

### MECHANICAL AREA

The area in and around the spa must be accessible for maintenance on spa shell, electrical control system, and equipment. Included in this manual are drawings that show minimum dimensions for this area. Sump pumps, drains, lighting, and HVAC controls must be designed before installation to ensure proper operation once the spa is installed.

The spa should be drained using a portable sump pump that is to be supplied by the owner. Care must be taken during the planning stages to make sure that drains are adequate to carry the sump discharge when the spa is drained for maintenance.

The floor of the spa area should be designed by a structural engineer to carry the combined weight of the spa, water and bather load. This floor area must be completely level to support the spa correctly. See "Overall Design Information" section for specifications.



## **TYPICAL WORK INVOLVED FOR INSTALLATION OF MASTER SPAS SPA**

---

Should the mechanical area be enclosed care must be taken to maintain an ambient temperature that is typical for enclosed mechanical rooms containing pool equipment. The equipment list below can be used to help determine the correct HVAC requirements during the design stages. This is a recommended list of standard and optional equipment in a typical spa installation:

- 1- Electric or gas heater
- 1- 1.5 hp filter pump
- 1- 1.5 hp therapy pump
- 1- 2.0 hp therapy pump
- 1- 50 amp (40 amp maximum ampacity) propulsion drive assembly

### **GENERAL CONTRACTOR INSTALLATION**

The spa room and mechanical area are to be constructed as per the owners design and following the guidelines set forth by local codes and the Master Spas Installation Guide.

All shipping and delivery fees are the responsibility of the owner, unless otherwise specified.

An opening in the building large enough to accommodate the spa will have to be planned for. See "Overall Design Information" section for dimensional specifications. The minimum path dimensions for the spa from the unloading site to the spa area should be approximately 10 feet wide by 6 feet 8 inches high (a site survey should be conducted and good judgement decisions should be made prior to installation day to prevent delays in the completion date due to space limitations). The spa is supported by its own steel frame and should remain upright to avoid damage to the acrylic shell. In the event that the spa would have to be set into a different position so as to allow entry, care must be taken to insure that no damage is done to the acrylic shell or supporting metal frame work.

Once the spa has been moved to the designated area it must be set on the previously constructed structural floor area. If the unit is to be recessed below the spa room floor, rigging will be needed to set it properly.

The acrylic on the spa should be protected during the construction process at all times. A temporary platform constructed of plywood and floor joists covered with a tarp is recommended. This will keep construction debris from accumulating in the spa and mechanical areas. Never use clear materials to protect the spa shell. Any damage caused by the use of clear protective materials, will not be covered by the warranty.

An electrical conduit chase running from the spa to the control area will be needed. This conduit should be sized appropriately to allow for the e-stop and VFD power cables to be routed.

Once the electrical and plumbing phases are completed, the spa will need to be cleaned, filled and the operation sequence started.

See "Specifications for Spa Room Area" in this section for information regarding ADA Compliant lift chair installation.

### **ELECTRICAL CONTRACTOR INSTALLATION**

The spa comes with its own GFCI breaker and must be wired according to the wiring diagram supplied in the drawings section. This GFCI is a special device that is unique to this spa. This special GFCI is designed to protect the patented propulsion system drive only. It must be wired directly to the incoming electrical service. DO NOT install a separate GFCI breaker on this

## TYPICAL WORK INVOLVED FOR INSTALLATION OF MASTER SPAS SPA

---

system. The installation will require the purchase of a separate sub panel to feed the pa control panel. An electrical wiring schematic is supplied in the drawings section.

All materials, equipment and labor needed to connect each electrical component must be provided.

Wiring and conduit must be installed as required by the local regulatory authority having jurisdiction to all of the system components listed below:

- 1- Electric and or gas heater (where installed)
- 1- Filter pump
- 1- Pump 1 therapy pump
- 1- Pump 2 therapy pump
- 1- Propulsion drive assembly
- 1- Freeze Protect Circuit (where installed)

*NOTE: See "Overall Design Information" section for electrical specifications for each model.*

The low voltage system interface wiring connecting the timer, emergency shut off, and spa control must also be installed as per code.

The conduit termination point should be sealed with a UL Listed sealing device. All wiring must be routed through approved conduit that is sized for the wire gauge being used. The conduits shall be terminated using a Liquidtite conduit. GFCI nuisance tripping and motor noise is reduced when using the metal conduit. In the event that local codes have additional requirements they must be followed.

The spa equipment must be grounded by way of a bonding wire in addition to the normal ground wiring of the electrical components. The use of this bonding wire will reduce nuisance tripping of the GFCI breaker. The gauge of this bonding wire must be the same gauge as the live conductor to insure that it is capable of carrying the current in the case of a short circuit.

Wire used must be a minimum of 75 degree centigrade stranded copper rated MTW or THHN. Solid copper wire of any kind is NOT to be used to GROUND components. Solid copper wire may be used to BOND metal parts per local code.

The electrical components used to operate this unit should be wired per the component manufacturers recommendations. All electrical components shall be protected by a G.F.C.I. The propulsion controller requires the installation of a special G.F.C.I. which has been supplied with the spa. All other electrical components shall be supplied by a circuit protected by a G.F.C.I. and installed in accordance with Local, and State law, and the NEC. In the event that one requirement is more restrictive, the more restrictive requirement shall be used.

An optional control box can be ordered that allows for most electrical control devices to be housed in a UL approved box and comprises of all UL approved components. Taking advantage of this control box will allow for a simple and quick electrical installation. Refer to the "Technical Drawings" section of this manual for electrical installation schematics used to wire the system with or without the optional control box.

The optional Control Box is capable of controlling the circulation pump (24 hour continuous), both therapy pumps, lights (on/off), propulsion system, e-stop, and timer (15 min.).

Before connecting to the spa electrical components, check the incoming power to confirm a voltage level of 216 – 264 VAC.

Connect bonding connection to the spa bonding lug located on the step entry side of the spa. Also verify that a bonding connection is made to the bonding block located on the opposite end of the pa where the propulsion VFD is located. Bonding connection, wiring and installation shall comply with the NEC and local codes.

# **TYPICAL WORK INVOLVED FOR INSTALLATION OF MASTER SPAS SPA**

---

## **PLUMBING CONTRACTOR INSTALLATION**

Provide all materials, equipment and labor needed to fulfill requirements set forth in the owner's contract. Install all interconnecting plumbing between the spa and the spa equipment as per the "Technical Drawings" section of this manual, and as required by the local regulatory authority having jurisdiction.

Install proper drains for maintenance and overflow. Provide drains in the sump area (if applicable), floor drains in the spa room and also a gravity drain(s) capable of handling the portable sump pump used to drain the spa.

All of the valves, fittings, etc. shall be NSF-50 or equivalent approved, all piping shall be at minimum schedule 40 NSF-50 or equivalent approved PVC attached with appropriately rated glue.

When the electrical contractor has confirmed operation of the motors and associated equipment, the spa is to be filled and all plumbing installed on site hydrostatically tested as required by the local regulatory authority having jurisdiction.

## **MECHANICAL CONTRACTOR INSTALLATION**

Provide all materials, equipment and labor needed to fulfill requirements set forth in the owner's contract. This will be done to satisfy conditions identified in the installation guide so as to provide proper ventilation, heating, dehumidifying, and air conditioning of the spa room. This also must be done in accordance with all applicable codes.

## **INITIALIZATION REQUIREMENTS**

### **Electrical Contractor:**

- Confirm power to systems.
- Before spa is filled confirm that all systems wiring conforms to installation guide wiring schematics and all local and state electrical codes.

### **Plumbing Contractor:**

- Confirm that all floor drains and sump pump(s) (if applicable) are fully operational
- Confirm that all plumbing is installed and conforms to proper configurations and that all valves are in the correct positions.
- Confirm that there are no leaks in the system.

### **General Contractor:**

- Clean and fill the spa.
- Confirm that all work has been completed and spa is functioning correctly.
- Install supplied warning safety sign in a location clearly visible from spa.

## **TYPICAL WORK INVOLVED FOR INSTALLATION OF MASTER SPAS SPA**

---

### **POSSIBLE AREAS OF CONCERN CHECK LIST**

Requirements dealing with setbacks not followed causing problems accessing equipment for service and inspection or failures of specific components due to poor design layout.

Poor air circulation around spa equipment due to inadequate estimation of heat loads.

All applicable local and state codes must be considered during the early design stages. Failure to do so will many times result in last minute changes that will hold up the final occupancy permits and cause work order changes.

Installation parameters must be clearly defined in bid orders to ensure that changed work orders do not cause delays and add excessive costs to the project.

An overall access plan that will be used throughout the construction project should be in place before beginning. Responsibility for this plan rests with the architect/general contractor. As work will have to be done by several contractors at varying times the importance of this plan is paramount. Considerations for covering the acrylic spa shell, provisions for sealing areas open to adverse weather, etc. must be taken.

Should the spa be installed in an existing building care must be taken to consider all of the factors involved during the design and bid stage. Potential problem areas can be, existing plumbing and electrical wiring, heating and air-conditioning runs, structural barriers, etc. Care must be taken to insure that all of the afore mentioned are addressed when planning for the delivery and moving the spa to its final location.

## INSTALLATION REQUIREMENTS

---

**The Inspection.** The spa owner or builder shall notify the authority having jurisdiction at specific, predetermined stages of construction and at the time of completion of the spa to permit inspections as may be required.

**Installation.** The spa and its equipment shall be supported to prevent damage from misalignment, settling, etc., and located in such a manner to allow access for inspection, servicing, removal and repair of component parts.

**Direct sunlight.** The spa shall be covered as a means to protect the spa when not in use from direct sunlight exposure. All exposed plumbing should be painted with a UV stable formulation to prevent UV damage to exposed plumbing. Usually black paint will satisfy this requirement.

**Circulation system piping.** Circulation system piping, other than that integrally included in the manufacture of the spa, shall be subject to an induced static hydraulic pressure test (sealed system) at 25 pounds per square inch (1.7577035 kg/sq. cm) for 30 minutes. This test shall be performed before the deck is poured, and the pressure shall be maintained throughout the deck pour.

Valves installed in or under any deck(s) shall provide a minimum of 9 inches (22.86 cm) diameter access cover and valve pit to facilitate servicing.

**Hose bibb.** A hose bibb with a vacuum breaker shall be provided for washing down the entire deck area.

**Circulation system components.** Components which require servicing shall be accessible for inspection and repair, and shall be installed in accordance with the manufacturer's specifications.

Spa equipment shall be properly supported to prevent damage from misalignment, settlement, operational movement, etc. The equipment shall be mounted so as to minimize the potential for the accumulation of debris and moisture, following manufacturer's specifications.

Equipment shall be designed and fabricated to drain the spa water from the equipment, together with the exposed face piping, by removal of drain plugs and by manipulating valves or by other methods.

In addition to programmed filtration times (if installed), recirculation equipment shall be in operation during the hours the spa is accessible for use.

All filter elements, media and other components which require servicing shall be accessible for inspection, removal and repair, and shall be installed in accordance with the filter manufacturer's instructions.

Pumps shall be accessible for inspection, service and maintenance.

Spas shall have a circulation, filtration, and treatment system consisting of equipment such as pumps, piping, fittings, return inlets, suction outlets, filters, skimmers and other necessary components that promote circulation of water throughout the spa. The circulation system shall be capable of:

- Producing a circulation turnover rate of the total water volume of the spa through the filtration system within 30 minutes or more quickly as determined by the local regulatory authority having jurisdiction.
- Not having a standby mode to reduce circulation and filtration rate below the minimum required by public health authority having jurisdiction.

**Grounding and bonding.** Grounding and bonding required in a public spa shall comply with the requirements of the National Electrical Code (NEC)®, ANSI/UL 1563 Standard for Electric Hot Tubs, Spas and Associated Equipment and the authority having jurisdiction.

See "Typical Work Involved for Installation of Master Spas Spa", "Electrical Contractor Installation" section for specific requirements.

**IMPORTANT NOTE.** Requirements for grounding and bonding are particularly important and shall be adhered to.

**Maintenance Disconnect Means.** Disconnecting means shall be accessible, located within sight of the electrical equipment and shall be located at least 5 feet (1.524 m) horizontally from the inside walls of the spa.

**Emergency Shut-off Switch.** A clearly labeled emergency shutoff or control switch for the purpose of stopping the motor(s) that provide power to the re-circulation system and jet system shall be installed readily accessible to the users and at least 5 feet (1.524 m) away, adjacent to and within sight of the spa.

## INSTALLATION REQUIREMENTS

---

**Heater Installation (if installed).** Heaters shall be installed in accordance with the authority having jurisdiction and in accordance with the manufacturer's specifications.

**Backflow.** No direct mechanical connection shall be made between the potable water supply and spa, sanitizing equipment or the system of piping for the spa, unless it is protected against backflow and back-siphonage in a manner approved by the authority having jurisdiction or through an air gap, meeting the latest ANSI A112.1.2 (R1991) standard.

**Water temperature.** Where installed, the heater manufacture shall provide instructions stating that the temperature of the in-coming make-up water shall not exceed 104°F (40°C) as recommended in ANSI/UL 1563, Standard for Electric Hot Tubs, Spas and Associated Equipment.

**Deck Depth Markers.** Depth markers shall be positioned on the deck within 18 inches (45.72 cm) of the waterline and shall be positioned to be read while standing on the deck facing the water.

Depth markers in or on the deck surfaces shall be slip-resisting.

**Clock.** All public facilities shall have a clock which is visible from the spa.

The spa operator shall be provided with an accurate thermometer  $\pm 1^\circ\text{F}$  ( $\pm 0.56^\circ\text{C}$ ) tolerance and shall periodically check to ensure that the maximum temperature does not exceed 104°F (40°C).

A means to determine the spa temperature with a  $\pm 1^\circ\text{F}$  ( $\pm 0.56^\circ\text{C}$ ) tolerance shall be provided to the user.

**Flowmeter.** An accurate flowmeter shall be installed after the circulation, filtration, and heating equipment, before the chemical feed system (see "Return Plumbing" drawings).

**Spa Use Sign.** Install supplied warning safety sign in a location clearly visible from spa.

**Supplemental water sanitation and treatment.** The applicable requirements of NSF/ANSI 50 shall apply to any equipment installed for use in treatment of spa water, including:

- Ozone systems, including NSF-50 Sections 11 and 12
- UV light systems, including NSF-50 Sections 11 and 13
- Copper and silver ion generators, including NSF-50 Sections 11 and 16.

**Entry/Exit Handrail.** An entry/exit handrail shall be provided to allow for safe entry and exit of the spa. This handrail shall be designed and installed in accordance with the local authority having jurisdiction. When installing and orienting the handrail, care must be taken to assure that the handrail works in conjunction with existing handrail(s) pre installed on the shell from the factory.

The product is equipped with some handrails that will serve the purpose below the level of the spa. It is imperative that Entry/Exit Handrails be considered with respect to all local codes prior to the purchase of the spa and construction of the project. Requirements vary drastically from local to local so a little research regarding handrails prior to kicking off the project will go a long way in getting permits, etc. approved during the construction process. It should be noted that the likelihood of designing, and purchasing different, and even possibly custom handrails to complete this project is high, and can delay the project if not properly considered during the design stage of the project. Consult your local authority having jurisdiction, Master Spas Customer Service, and/or a handrail manufacturer for any questions you may have.

**Barrier.** A listed ASTM F1346 lockable safety cover shall be the minimum barrier requirement. Check all local and state codes provided by the local authority having jurisdiction for additional or more restrictive requirements. Should the code(s) have a more restrictive requirement, the more restrictive requirement shall be the minimum installation requirement.

**Lift Chair.** An ADA compliant lift chair shall be installed in accordance with the manufacturers recommendations and shall comply with all ADA regulations. See "Overall Design Information" section for recommendations.

## TYPICAL CODE REQUIREMENTS

---

**The Inspection.** The spa owner or builder shall notify the authority having jurisdiction at specific, predetermined stages of construction and at the time of completion of the spa to permit inspections as may be required.

**Installation.** The spa and its equipment shall be supported to prevent damage from misalignment, settling, etc., and located in such a manner to allow access for inspection, servicing, removal and repair of component parts.

**Roofs or canopies.** Solid roofs or canopies over spas shall be constructed so that water run-off does not drain into the spa.

**Ladders.** The design and construction of spa ladder(s), where used, shall conform to articles 5.6.3.1 through 5.6.3.6. As per BSR/APSP-2 Standard for Public Spas.

Spa ladder(s) shall be made entirely of corrosion-resisting materials.

Ladder treads shall have a slip-resisting surface.

Ladder(s) shall be provided with two (2) handholds/handrails.

The outside diameter of a ladder rail shall be between a minimum of one inch (1") [2.54 cm] and a maximum of one and nine-tenths inches (1.9") [4.826 cm].

Below the water level, there shall be a clearance of not more than six inches (6") [15.24 cm] nor less than three inches (3") [7.62 cm] between any ladder tread edge, measured from the spa wall side of the tread and the spa wall.

The clear spread between ladder handrails shall be a minimum of 17 inches (43.18 cm) and a maximum of 24 inches (60.96 cm).

### DECKS

**New construction areas.** These guidelines shall apply to deck area at or immediately around the spa.

Work for concrete deck(s) shall be performed in accordance with local construction practices and the recommendations of the latest American Concrete Institute (ACI) Standard 302.1R-80, "Guide for Concrete Floor and Slab Construction".

**Slip-resisting.** All deck surfaces shall be of slip resisting materials, including but not limited to special deck features such as markers and brand insignias.

**Riser dimensions.** Risers for deck steps shall be uniform and have a maximum height of 71/2 inches (19.05 cm). The minimum tread depth shall be 10 inches (25.4 cm).

**Subgrade.** The subgrade for decks shall be prepared and/or installed in accordance with engineering practices required in the area of installation or methods required by the authority having jurisdiction.

**Unobstructed deck.** A minimum 4 feet (1.2192 m), unobstructed deck, including the coping, shall be provided around at least 50 percent of the spa.

## TYPICAL CODE REQUIREMENTS

---

**Slope.** Decks shall be sloped to effectively drain towards the perimeter areas or to deck drains. Typical slopes for immediate spa decking are:

- a) 1/8 inch per 1 foot (1.04166 cm: 1 m) shall be provided for textured, hand-finished concrete decks;
- b) 1/4 inch per 1 foot (2.08333 cm: 1 m) for exposed aggregate concrete decks;
- c) 1/2 inch per 1 foot (4.16666 cm: 1 m) for indoor/outdoor carpeted concrete decks, unless an alternative drainage method is provided.

The maximum slope for wood decks shall be 1/8 inch per 1 foot (1.04166 cm: 1 meter).

Gaps shall be based on good engineering practices with respect to the type of wood used.

**Expansion joints.** Expansion control joints shall be provided to help control cracks due to expansion, contraction, and movement of the slab.

**Sharp corners.** Decks shall be chamfered or otherwise relieved to eliminate sharp corners.

**Drainage.** Site drainage shall direct all deck drainage as well as general site and roof drainage away from the spa. Where required, yard drains shall be installed to prevent the accumulation or puddling of site water in the general area of the deck(s) and related improvements.

**Backwash sump.** If used, a backwash sump shall be located so that it falls completely below adjacent deck(s) and fully outside a line projected 45° downward and away from the deck(s) or shall be designed to accommodate local soil conditions and the volume of backwash.

**Circulation system piping.** Circulation system piping, other than that integrally included in the manufacture of the spa, shall be subject to an induced static hydraulic pressure test (sealed system) at 25 pounds per square inch (1.7577035 kg/sq. cm) for 30 minutes. This test shall be performed before the deck is poured, and the pressure shall be maintained throughout the deck pour.

Valves installed in or under any deck(s) shall provide a minimum of 9 inches (22.86 cm) diameter access cover and valve pit to facilitate servicing.

**Hose bibb.** A hose bibb with a vacuum breaker shall be provided for washing down the entire deck area.

**Filtration Duration.** In addition to programmed filtration times (if installed), recirculation equipment shall be in operation during the hours the spa is accessible for use.

**Grounding and bonding.** Grounding and bonding required in a public spa shall comply with the requirements of the National Electrical Code (NEC)®, ANSI/UL 1563 Standard for Electric Hot Tubs, Spas and Associated Equipment and the authority having jurisdiction.

**IMPORTANT NOTE.** Requirements for grounding and bonding are particularly important and shall be adhered to.

**Maintenance Disconnect Means.** Disconnecting means shall be accessible, located within sight of the electrical equipment and shall be located at least 5 feet (1.524 m) horizontally from the inside walls of the spa.



## TYPICAL CODE REQUIREMENTS

---

**Emergency Shut-off Switch.** A clearly labeled emergency shutoff or control switch for the purpose of stopping the motor(s) that provide power to the re-circulation system and jet system shall be installed readily accessible to the users and at least 5 feet (1.524 m) away, adjacent to and within sight of the spa. Additional requirements may need to be considered such as available or visual indication that the emergency shut-off switch is activated. Check with the local authority having jurisdiction for compliance requirements.

**Heater Installation.** Heaters shall be installed in accordance with the authority having jurisdiction and in accordance with the manufacturer's specifications.

**Support.** Heaters shall be installed on a surface with sufficient structural strength to support the heater when it is full of water and operating. The heater shall be stable and not able to move after plumbing, gas and/or electrical connections are completed.

**Combustible surfaces.** If the heater requires a non-combustible mounting surface per the manufacturer's specification, it shall be placed on a concrete or other listed surface and comply with ANSI Z21.56a-1996 or with the authority having jurisdiction.

**Clearances.** All heaters shall be installed and maintained with the minimum clearances to combustibles for which the heater has been tested as specified by the manufacturer's specification.

**Ventilation.** All spas and their related components installed in an indoor spa environment, shall comply with the ventilation requirements of ANSI/ASHRAE 62-2001, Ventilation for Acceptable Indoor Air Quality, Table 2-Section 2.1. (For additional information on ventilation/ humidity guidelines for indoor spas, see the 1999 ASHRAE Handbook, HVCA Applications, I-P Edition, 4.5, 4.6. and 4.7\*)

**Make up air.** When installing a fossil fuel heater indoors, proper openings to the room are required. The heater shall be installed in accordance with the authority having jurisdiction and the manufacturer's specifications for properly sized and located air openings to the enclosure.

**Important safety consideration.** Fossil fuel appliances like spa heaters produce poisonous carbon monoxide gas as a by-product of combustion. Proper venting of exhaust gases and the correct sizing of gas meters, gas supply piping, make-up air intake, etc. are critical installation considerations in preventing potential carbon monoxide gas poisoning or loss of life.

### HEATING ENERGY SOURCE

**Natural gas energy supply.** The heater gas supply piping shall comply with manufacturer's specifications and ANSI/NFPA 54, National Fuel Gas Code.

**Important safety note.** Install a gas cock, properly sized and readily accessible outside the jacket, to stop the flow of natural gas at the heater for service or emergency shutdown.

**Propane energy supply.** Whenever a propane (LPG) appliance is installed, special attention shall be given to ensure that the storage tank, supply piping and regulator shall be adequately sized to ensure operating fuel pressures as specified by the appliance manufacturer. Consult the fuel supply company and ensure that the system is installed in accordance with the National Fuel Gas Code (ANSI Z223.1/NFPA 58-2004), or equivalent.

**Important safety note.** Propane gas is heavier than air and therefore can create an extreme hazard of explosion or suffocation if the heater is installed in a pit or enclosed area. NFPA -58 contains provisions for installing valves and other controls in pits and similar areas.

## TYPICAL CODE REQUIREMENTS

---

**Electrical supply.** Electric heating appliances shall be installed in accordance with the National Electrical Code (NEC) ® and with the requirements of the authority having jurisdiction.

**Important safety note.** The requirements for grounding and bonding are particularly important and shall be adhered to.

**Backflow.** No direct mechanical connection shall be made between the potable water supply and spa, sanitizing equipment or the system of piping for the spa, unless it is protected against backflow and back-siphonage in a manner approved by the authority having jurisdiction or through an air gap, meeting the latest ANSI A112.1.2 (R1991) standard.

**Water temperature.** Where installed, the heater manufacture shall provide instructions stating that the temperature of the in-coming make-up water shall not exceed 104°F (40°C) as recommended in ANSI/UL 1563, Standard for Electric Hot Tubs, Spas and Associated Equipment.

### WASTE WATER DISPOSAL

Backwash water is permitted to be discharged into a sanitary sewer through an approved air gap into an approved subsurface disposal system or by other means approved by the authority having jurisdiction.

### SANITIZING, OXIDATION EQUIPMENT AND CHEMICAL FEEDERS

**Compliance.** Sanitizing equipment, oxidation equipment and chemical feeders, shall comply with the most recent edition of ANSI/NSF-50 Circulation System Components and Related Materials for Swimming Pools, Spas/Hot Tubs. The sanitizing equipment and the chemical feeders shall be capable of introducing a sufficient quantity of a sanitizer.

**Chemical feeders.** The installation and use of chemical feeders shall conform to articles 17.2.1 through 17.2.2. As per BSR/APSP-2 Standard for Public Spas.

A chemical feed system shall be installed in accordance with the manufacturer's specifications.

Chemical feed pumps shall be wired so they cannot operate unless there is adequate return flow to properly disperse the chemical throughout the spa as designed.

**Training.** Personnel responsible for the operation of the sanitizing agent equipment shall be properly trained in the operation of that equipment, the procedure for performing and interpreting the required onsite chemical tests, and the appropriate emergency procedures.

If the equipment is located in a closed room and capable of exposing maintenance or service personnel to ozone concentrations exceeding federal, state, or local air standards, a self-contained breathing apparatus approved for ozone usage shall be provided. If a distinct, pungent odor is smelled when the ozone generating equipment is operating, the equipment shall be shut down and the area shall be ventilated. The equipment shall be inspected and repaired as required per the manufacturer's specifications.

## TYPICAL CODE REQUIREMENTS

---

### SAFETY FEATURES

Public spas are for swimming, exercising, hydrotherapy and wading only. No diving boards, slides or other equipment are to be added to a public spa that in any way indicates that it may be used or intended for diving or sliding purposes.

**Unauthorized access.** The spa shall be secured to protect against unauthorized access. Consult the authority having jurisdiction for barrier guidelines. (See also ANSI/APSP-8, Model Barrier Code for Residential Swimming Pools, Spas and Hot Tubs).

**Maintenance disconnect switch.** Disconnecting means shall be accessible, located within sight of the spa electrical equipment and shall be located at least 5 feet (5') [1.524 m] horizontally from the inside walls of the spa.

The disconnecting means shall be clearly labeled "Safety Disconnecting Switch Use only." It shall not be used as an emergency switch.

**Emergency shut-off switch.** A clearly labeled emergency shutoff or control switch for the purpose of stopping the motor(s) that provide power to the re-circulation system and jet system shall be installed readily accessible to the users and at minimum of 5 feet (1.52m) away, adjacent to and within sight of the spa.

**Spa light.** The spa light operation requirement is typically either 24 hour operation, or required to be on at least during time that the spa is open to the public.

**Safety literature.** The spa owner, or their representative shall be advised by the installing agent of the available publications related to spa safety. These documents may include but not limited to APSP booklets entitled: "Children Aren't Waterproof", "Pool and Spa Emergency Procedures for Infants and Children", "Layers of Protection" and "The Sensible Way to Enjoy Your Spa."

**Instructions/safety signs.** The installing agent shall provide instructions to inform the owner to post signage in a prominent location which states the safety, emergency and operational aspects of the spa. As a guide for language and layout of the safety signs, reference ANSI Z-535, Series of Standards for Safety Signs and Colors and ANSI/UL 1563, Standard for Electric Hot Tubs and Associated Equipment. An ANSI/UL1563 sign has been supplied with the spa.

**Spa use sign.** The spa instructions shall inform the operator to post the spa use parameters sign in a prominent location adjacent to the entrance of the spa.

Safety signs shall include but not be limited to the messages below.

1. Risk of Drowning - Persons suffering from heart disease, diabetes, high or low blood pressure and other health problems should not enter the spa without prior medical consultation and permission from their doctor.
2. Risk of Drowning - Do not use the spa while under the influence of alcohol, narcotics, or other drugs that cause sleepiness, drowsiness or raise/lower blood pressure.
3. Risk of Drowning - Use caution when bathing alone. Over exposure to hot water may cause nausea, dizziness and fainting. Lower water temperatures are recommended for extended use (exceeding 10-15 minutes) and for young children.
4. Risk of Drowning - Do not allow the use of or operate spa if suction outlet cover is missing, damaged or loose.
5. Risk of Drowning - Spa heat speeds up effects of alcohol, drugs, or medicine and can cause unconsciousness.
6. Risk of Drowning - Immediately leave spa if uncomfortable or sleepy.
7. Risk of Child Drowning -Unsupervised use of spa by children is prohibited.

## TYPICAL CODE REQUIREMENTS

---

8. Water attracts children.
9. Risk of Fetus Injury - Hot water exposure limitations vary from person to person. Pregnant women and small children should not use spa prior to medical consultation.
10. Risk of Fetus Injury - During pregnancy, soaking in hot water may cause damage to fetus. Limit use to 10 minutes at a time after medical consultation.
11. Risk of Injury - Before entering the spa, check water temperature. The spa water temperature should not exceed 104°F (40°C).
12. Risk of Injury - Enter and exit slowly.
13. Risk of Injury - Keep all breakable objects out of the spa.
14. Risk of Shock - Never place electrical appliances (telephone, radio, television, etc.) within five (5) feet (1.524 m) of the spa.
15. Risk of Shock - The spa shall not be operated during severe weather conditions, i.e. electrical storms, tornadoes, etc.
16. Prevent Unauthorized Use - Secure the facility and spa against unauthorized access. Where used, attach spa cover after each use.
17. No climbing or walking on top rail.
18. No Diving / No Jumping - Diving or jumping may cause death, paralysis, or permanent injury.

**Emergency telephone signs.** A sign shall be posted in the immediate vicinity of the spa, stating the spa address, the location of the nearest telephone, and that emergency telephone numbers are posted by this telephone. Those emergency telephone numbers shall include the name and phone number of the nearest available police department, fire department, ambulance service, and/or rescue unit, and/or "911," if available.

**Operational signs.** Operational signs shall include but not be limited to the following messages:

1. Do not allow the use of or operate spa if the suction outlet cover is missing, damaged or loose.
2. Check spa temperature before each use. Do not enter the spa or if the temperature is above 104°F (40°C).
3. Secure the facility against unauthorized access. (See ANSI/APSP-8, Model Barrier Code for Residential Swimming Pools, Spas and Hot Tubs).
4. Keep all breakable objects out of the spa.
5. Spa shall not be operated during severe weather conditions, i.e. electrical storms, tornadoes, etc.
6. Never place electrical appliances (telephone, radio, television, etc.) within 5 feet (1.524 m) of the spa. Depth markers shall be positioned on the deck within 18 inches (45.72 cm) of the waterline.

Deck depth markers shall be positioned on the deck within 18 inches (45.72 cm) of the waterline and shall be positioned to be read while standing on the deck facing the water. Depth markers in or on the deck surfaces shall be slip-resisting.

## TYPICAL CODE REQUIREMENTS

---

**Clock.** All public facilities shall have a clock which is visible from the spa.

The spa operator shall be provided with an accurate thermometer  $\pm 1^{\circ}\text{F}$  ( $\pm 0.56^{\circ}\text{C}$ ) tolerance and shall periodically check to ensure that the maximum temperature does not exceed  $104^{\circ}\text{F}$  ( $40^{\circ}\text{C}$ ).

A means to determine the spa temperature with a  $\pm 1^{\circ}\text{F}$  ( $\pm 0.56^{\circ}\text{C}$ ) tolerance shall be provided to the user.

### DRESSING FACILITIES

The minimum criteria for dressing and sanitary facilities shall be based upon the anticipated maximum attendance of users and their gender.

### OPERATION AND MANAGEMENT

Supervision/training. Public spas shall be maintained under the supervision and direction of a properly trained and certified operator who shall be responsible for the sanitation, safety, and proper maintenance of the spa and all physical, mechanical equipment and records. (Training can be obtained by completion of the National Swimming Pool Foundation's Pool/ Spa Operator's Training Course CPO), and the National Parks and Recreation (AFO)

**Instructions.** Upon completion of construction of any public spa, the manager and the operators shall be given complete written and oral instructions by the builder as well as instructions for operating the spa and all equipment and for the continuous sanitation of the spa water.

**Water temperature.** Owner/operator should routinely check the in-spa water to ensure that the temperature does not exceed  $104^{\circ}\text{F}$  ( $40^{\circ}\text{C}$ ), as recommended in ANSI/UL 1563, Standard for Electric Hot Tubs, Spas and Associated Equipment. If adjustments are necessary, those adjustments shall be performed in accordance with manufacturer's specifications.

Rules and regulations for users shall be posted in a conspicuous place.

**User load.** The maximum user load shall not exceed one (1) person per 9 square feet (0.8361 sq. m) of surface area.

The user load limit shall be observed by the management. The maximum number of users to be allowed in the spa at one time shall be determined and will depend on a number of factors such as the design of the spa, user's use pattern, surface area of the spa, operating characteristics of the water purification system with the significant factors being the spa area and the sanitary and physical condition of the spa water under maximum usage.

**Barrier.** A listed ASTM F1346 lockable safety cover shall be the minimum barrier requirement. Check all local and state codes provided by the local authority having jurisdiction for additional or more restrictive requirements. Should the code(s) have a more restrictive requirement, the more restrictive requirement shall be the minimum installation requirement.

### OPERATING PERMITS

A public spa shall not operate until such time as the appropriate permit required has been submitted to the authority having jurisdiction.

The spa shall not be placed in operation until appropriate inspections show compliance with the guidelines set forth in this manual, and all codes set forth by the local authority having jurisdiction.

## TYPICAL CODE REQUIREMENTS

---

If the authority having jurisdiction makes a regular inspection of the spa to determine compliance with applicable permit or requirements, the spa owner and/or operator shall correct all noted deficiencies before placing the spa in operation and accessible to users. In the absence of such an inspection, the owner and/or operator shall perform a documented self-inspection of the spa and file in their records a checklist noting each deficiency noted and a follow-up statement after these have been corrected, and to maintain records for a period of three (3) years.

Should any inspections, including self-inspection, of the spa reveal a condition which does or may constitute a health or safety hazard for users, the owner and/or operator shall prevent any person from using it until the hazard has been satisfactorily corrected. If the authority having jurisdiction cited the violation, that agency shall be notified to make a follow-up inspection before the spa is reopened.

The revoked or suspended permit shall not be reissued or reinstated unless presented with evidence that the deficiencies which caused the revocation or suspension have been corrected. Such evidence shall be in the form of a re-inspection by the authority having jurisdiction.

## WATER CHEMISTRY TERMS YOU SHOULD KNOW

---

**Before jumping into the Spa Water Maintenance, here are some terms to help you.**

1. **Parts per million, or ppm:** This is a form of measurement used in most spa chemical readings. Best described as any one million like items of equal size and make up, next to one unlike item, but of equal size. This would be one part per million.
2. **Total Alkalinity:** This is a measurement of the ability of the water to resist changes in pH. Put another way, it is the water's ability to maintain proper pH. Total alkalinity is measured in parts per million from 0 to 400 plus, with 80 to 120 ppm being the best range for spas. With low alkalinity, the pH will flip, or change back and forth, and be hard to control. With high alkalinity it becomes extremely difficult to change the pH.
3. **pH or potential hydrogen:** This is a measurement of the active acidity in the water, or it is the measurement of the concentration of active hydrogen ions in the water. The greater the concentration of active hydrogen ions, the lower the pH. pH is not measured in parts per million, but on a scale from 0 to 14, with 7 being the neutral. In spas when ever possible, a measurement between 7.2 and 7.8 is best. Whenever possible, it should be between 7.4 and 7.6. With low pH, the results can be corroded metals, etched and stained plaster, stained fiberglass or acrylic, eye / skin irritation, rapid chlorine or bromine loss, and total alkalinity destruction. With high pH, the results can be cloudy water, eye / skin irritation, scale formation and poor chlorine or bromine efficiency.
4. **Shocking:** This is when you add either extra chlorine (superchlorinate) by raising the chlorine level above 8 ppm, or add a non-chlorine shock (potassium monoperoxysulfate or potassium monopersulfate) to burn off the chloramines or bromamines. A non-chlorine shock acts by releasing oxygen in the water, which serves the same function as chlorine. The advantage to using non-chlorine shock, is you can enter the water within 15 minutes after shocking. Using chlorine, you must wait until the total chlorine reading is below 5 ppm. One thing to remember, a non-chlorine shock will not kill bacteria or disinfect.
5. **Sequestering:** This can be defined as the ability to form a chemical complex which remains in solution, despite the presence of a precipitating agent (i.e. calcium and metals). Common names for sequestering chemicals are; minquest, stain and scale control, metal-x, spa defender, spa metal gone, (etc.).
6. **Filtration:** Filters are necessary to remove particles of dust, dirt, algae, etc. that are continuously entering the water. If the spa is not operated long enough each day for the filter to do a proper job, this puts a burden on the chemicals, causing extra expense. A spare cartridge should be kept on hand to make it easy to frequently clean the cartridge without the need for a long shut down. This will also allow the cartridge to dry out between usages, which will increase the cartridge life span as much as twice. Replace the cartridge when the pleats begin to deteriorate. Cartridge cleaning should be done a minimum of once a month. More often with a heavy bather load.

## Water Chemistry Terms You Should Know

---

7. **Sanitizers:** This is what kills the germs and bacteria that enter the water from the environment and the human body.
    - A. Chlorine
      1. Chlorine is an immediate sanitizer.
    - B. Bromine
      1. Two types of tablets.
        - a. Hydrotech
        - b. Lonza
      2. Bromine is a slow dissolve chemical and may take a few days to develop a reserve or reading in the water.
  8. **Total dissolved solids (TDS):** Materials that have been dissolved by the water. i.e. Like what happens when you put sugar in coffee or tea.
  9. **Useful life of water (in days):** Water should be drained at least once every 180 days. Useful life may vary by usage and bather load.
  10. **Defoamer:** Foaming may be caused by body oils, cosmetics, lotions, surface cleaners, high pH or algaecides as well as other organic materials. Low levels of calcium or sanitizer can also cause foaming. Also, double rinse your bathing suits as they will hold residual soap after being washed.
  11. **Calcium hardness:** Water that is too hard (over 250 ppm) can promote scale formation in components and on spa surface. Water that is too low (below 180 ppm) may also shorten the life of metal components on the spa.
- NOTE:** Always leave spa cover open for 15 min. after adding chemicals to prevent off gas from damaging your cover, and other critical parts.



## **Basic Chemical Safety Guidelines**

---

Keep all chemical containers sealed and out of reach of occupants

Read and follow all label directions

NEVER mix products

Accurately measure products

Store products in a cool, dry place

Never store products in direct sunlight

Always handle products with great care

Proper ventilation shall be provided for rooms where chemicals will be stored and used

Never store basic and acidic chemicals near each other

## WATER QUALITY MAINTENANCE START-UP

---

- Step 1:** Your spa should be filled using a Pre-filter, which can be obtained from your local dealer. This Pre-filter will help remove many of the minerals existing in the water, which will make adjusting the water balance easier after a new fill.
- Step 2:** During the initial filling of the spa, add a sequestering agent to combat suspended minerals in the water. The agents are sold under many different names such as Mineral Clear, Stain and Scale, and other brands.
- Step 3:** Test water for pH, total Alkalinity, and Calcium hardness. The pH should be 7.2 - 7.8 and the total Alkalinity 80-150 PPM. Calcium hardness levels should be maintained between 150 and 250 PPM (part per million).
- Step 4:** Adjust pH, total Alkalinity (TA) and Calcium hardness utilizing the directions on the chemical bottles provided by your dealers start up kit.
- Step 5:** It may be necessary to retest and add additional chemicals to get to the proper levels in Step 3.
- Step 6:** Add sanitizer. It is important not to add sanitizer until the pH, alkalinity and calcium hardness have been adjusted to their proper levels.

*Master Spas, Inc. products are not designed to be used with Biquanides. These chemicals are found in SoftSwim® and Baqua Spa® products. Due to adverse effects from these types of sanitizers, the use of these products may void the spa warranty.*

## SPA WATER MAINTENANCE – START-UP

---

**USE ONLY SPA CHEMICALS** (some pool chemicals are not suitable for spa use).

\* Maintaining your sanitizer at the recommended levels at all times will decrease the occurrence of unsafe bacteria in your spa water.

\* When adding chemicals, broadcast chemical across a large amount of surface area to prevent a high concentration in a small area.

1. Clean the surface with a spa general purpose cleaner or wipe down with a clean wet towel.
2. Begin filling the spa with fresh water. If possible, do not use softened water.
3. When the spa has 2 to 4 inches of water on the bottom, add the recommended amount of a sequestering chemical for that size spa. See the chemical bottle for correct amounts.
4. When the spa is full, run the pumps. This will give the sequestering chemical time to mix well with the water. Allow sequestering chemical 12-24 hours to properly filter in the water before proceeding with any further steps.
5. Using test strips or a test kit, test for total alkalinity, and adjust if necessary to between 80 to 150 ppm using the pH / alkalinity increaser or decreaser 5 oz. at a time. Wait 30 minutes, retest, and adjust if necessary. The pumps should be running during this time.
6. Using test strips or a test kit, test for pH, and adjust if necessary to within the 7.2 and 7.8 range using the pH / alkalinity increaser or decreaser 2.5 oz. at a time. Wait 30 minutes, retest, and adjust if necessary. The pump should be running on high speed during this time.
7. Add the sanitizer of choice, following label directions. Wait 30 minutes, retest, and adjust if necessary to a total chlorine reading of 1 to 3 ppm. If bromine is used, follow label directions. With the pump running, add bromine and shock to the spa with 10 oz. of non chlorine shock.
8. If any foam develops, add a defoamer at the base of the problem area. Use only enough defoamer to get rid of the foam. This is usually two to four drops. Do not pour large amounts of defoamer into water.

### **Water Sanitation via Chlorine and Bromine**

Water sanitation in the spa shall be accomplished using chemicals registered by the United States Environmental Protection Agency (EPA) under the Federal Insecticide, Fungicide, and Rodenticide Act. The applicable requirements of NSF/ANSI Standard 50 shall apply to equipment supplied by the installer for use in chlorine/bromine sanitation.

**NOTE:** Maintaining your sanitizer at the recommended levels at all times will decrease the occurrence of unsafe bacteria in your spa water.

## SPA WATER MAINTENANCE: TROUBLE-SHOOTING GUIDE

---

<b>Problem</b>	<b>Possible Causes</b>	<b>How To Fix It</b>
Sanitizer Odor	<ul style="list-style-type: none"><li>• Excessive sanitizer level</li><li>• Low pH</li></ul>	<ul style="list-style-type: none"><li>• Shock water with non-chlorine shock treatment</li><li>• Adjust pH if necessary</li></ul>
Water Odor	<ul style="list-style-type: none"><li>• Low levels of sanitizer</li><li>• pH out of range</li><li>• Bacteria or algae growth</li></ul>	<ul style="list-style-type: none"><li>• Shock water with non-chlorine shock treatment or adjust sanitizer levels</li><li>• Adjust pH level if necessary</li><li>• Adjust sanitizer if necessary</li></ul>
Cloudy Water	<ul style="list-style-type: none"><li>• Dirty filters or inadequate filtration</li><li>• Water chemistry not balanced</li><li>• Suspended particles or organic materials</li><li>• Old water</li></ul>	<ul style="list-style-type: none"><li>• Clean filters and adjust filtration</li><li>• Adjust chemistry levels</li><li>• Add spa clarifier (see dealer)</li><li>• Change spa water</li></ul>
Scum Ring Around Spa	<ul style="list-style-type: none"><li>• Build up of oils, dirt and organic elements</li></ul>	<ul style="list-style-type: none"><li>• Wipe off with a clean towel</li></ul>
Eye / Skin Irritation	<ul style="list-style-type: none"><li>• Unsanitary water</li><li>• Free sanitizer level above 5 ppm</li><li>• Poor sanitizer / pH levels</li></ul>	<ul style="list-style-type: none"><li>• Shock spa with non-chlorine shock</li><li>• Allow level to drop below 5 ppm</li><li>• Adjust according to spa test strip results</li></ul>
Foaming	<ul style="list-style-type: none"><li>• High levels of body oils, lotions, soap, etc.</li></ul>	<ul style="list-style-type: none"><li>• Add small amount of defoamer</li></ul>

## WHY WATER MAINTENANCE IS IMPORTANT IN A SPA

---

### 1. Evaporation:

As water evaporates, only pure water evaporates, leaving the salts, minerals, metals, and any unused chemicals behind. Adding water adds more salts, minerals, and metals. In time, the water can become saturated with these dissolved solids and can cause stains or scale to form on the walls of the spa or a scale build up inside the equipment. Colored or cloudy water, and possible corrosion of plumbing and fittings may also occur.

### 2. Heat:

Heat causes much quicker evaporation and also will cause minerals and metals to precipitate out of solution.

### 3. Air:

Dust and airborne dirt particles are introduced into the spa.

### 4. Environment:

The environment surrounding the spa can also impact the water quality. Items such as pollen, grass, sand, dirt, lawn fertilizer, airborne dust, insects, leaves, and pets can all affect the water quality of the spa.

### Remember:

The maintenance routines set forth in this manual may need to be adjusted depending on how much the spa is being used and requirements set forth by the local authority having jurisdiction.

## **SPA WATER MAINTENANCE RECOMMENDATIONS**

---

The spa requires periodic draining and cleaning to ensure a safe, healthy environment. It is recommended that you clean your spa at least every 180 days. Heavy bather load will require cleaning it more often.

### **CHEMICAL TEST FREQUENCY**

- Spa water should be tested at least every day. More frequent tests should be conducted during high bather load conditions. Chemicals shall be maintained within the guidelines set forth in the Water Quality Maintenance sections of this manual.

### **DRAIN YOUR SPA**

1. Due to the physical size of the spa, we recommend draining your spa with a submersible sump pump. Draining your spa with a conventional spa drain is not a reasonable option in some cases.
2. Use a shop vac to get all standing water out of the spa.
3. Loosen all pump unions
4. Remove winterizing plug from face of the pump(s) where applicable.
5. Using your shop vac in a blowing mode, insert the hose into the nozzle of each jet and blow the trapped water from the lines into the interior of the spa.
6. Connect a hose to the manifold drains located on the step side of the unit to drain manifolds.
7. After this is completed, use the shop vac to remove any standing water in the spa and in the equipment area.

### **CLEAN YOUR SPA SURFACE**

- With a soft cloth, wipe down the spa surface with a non-abrasive spa surface cleaner. Do not use paper towels. Be sure to rinse residue from spa surface.

### **REFILL YOUR SPA**

- Fill the spa with water and be sure that water level is above the skimmer opening at the minimum safe water level. Under no circumstances should the spa water line be allowed to drop below the minimum safe waterline mark on the skimmer faceplate.

### **CLEAN YOUR FILTER ELEMENT**

The filter is one of the most important components of your spa. It not only is essential for clean water, but also for extending the life of the spa equipment. Your filter element must be cleaned regularly (once a month on average) with normal spa use. With heavy use, they will need to be cleaned more often.

- Turn off the spa before servicing filters. Never leave to the spa running when removing the filters. Debris can be pulled into the plumbing system and cause unwarranted damage.
- With a garden hose, spray each element under pressure.
- Replace filter elements.
- Be sure water level is adequate.
- Turn spa on.
- Verify that operating pressure has dropped back down to the acceptable range.

### **CHECK WATER CLARITY**

- Never open the spa to the public if water clarity is in question. Water clarity can be checked with a Secchi Disk.

### **SECCHI DISK**

- Lower to the bottom of the spa. If the disk is not completely visible, do not open spa until water clarity problem is corrected.

## WINTERIZING YOUR SPA

---

1. Due to the physical size of the spa, we recommend draining your spa with a submersible sump pump. Draining your spa with a conventional spa drain is not a reasonable option in some cases.
  2. Loosen all pump unions
  3. Remove winterizing plug from face of the pump(s) where applicable.
  4. Using your shop vac in a blowing mode, insert the hose into the nozzle of each jet and blow the trapped water from the lines into the interior of the spa.
  5. Connect a hose to the manifold drains located on the step side of the unit to drain manifolds.
  6. After this is completed, use the shop vac to remove any standing water in the spa and in the equipment area.
  7. Clean the spa with a soft cloth and a non-abrasive spa surface cleaner.
  8. Replace access panels.
  9. Cover spa to prevent water from entering the vessel.
- \* If you decide to winterize your spa, we recommend that you periodically check the unit throughout the winter to assure water is not entering through or around the cover.

## **INSTRUCTIONS FOR MULTIPLE DAY PERIODS OF NO USE OF SPA**

---

1. Water chemistry shall be monitored and adjusted for various bather load conditions such as multiple day periods of no use of spa to prevent under and over chlorination. This is particularly important when a sanitization system that does not measure sanitization level is installed.
2. If the spa is not used for a 24 hour period, the jet pumps shall be turned on for 15 minutes to purge the water in the plumbing lines out and into the body of water.



## SPA TROUBLE-SHOOTING GUIDE

---

**WARNING** - Service and repair shall only be performed by a qualified technician. Customer shall not attempt to repair serviceable or non serviceable parts.

Exceptions:

- Clean/replace filter cartridge
- Replenish chemical feed system as directed by service professional

### PROPULSION SYSTEM

#### Breaker trips when turning the propulsion system on/off

1. Verify that the G.F.C.I. installed on the input power line to the propulsion system is protected by the factory supplied G.F.C.I.
2. Verify that only 1 G.F.C.I. is installed on the input power line to the propulsion system.
3. Verify sufficient voltage at G.F.C.I. and propulsion system (240V +- 10%)
4. Replace motor
5. Replace VFD
6. Replace G.F.C.I. / Breaker assembly

#### Press "SPEED UP/ON" and nothing happens

1. Verify voltage to VFD (240V +- 10%)
2. Verify no error codes on VFD display
3. Verify good connection on all VFD wires
4. Verify that control panel is plugged in firmly
5. Replace topside control panel
6. Replace VFD

#### Press "SPEED UP/ON" and display indicators come on, but no water flow from propulsion unit

1. Verify proper wiring between VFD and motor
2. Check voltage from VFD to motor
  - a. If no voltage from VFD to motor, replace VFD
  - b. If sufficient voltage to motor, replace motor

#### Display indicates system is on, sounds like motor is running, but no water flow from propulsion system

1. Verify that belt/pulley system is intact and moving
2. Remove prop and inspect for failure

**WARNING** - NEVER remove propulsion grates without first powering down at the breaker.

#### Loud squealing noise coming from propulsion system

1. Verify belt tension
2. Replace bearing assembly

#### Propulsion system will not shut all the way down

1. Hold down the "SPEED DOWN/OFF" button for 7 seconds

#### Jet pumps will not turn on

1. Verify that E-stop is not tripped
2. Turn timer
3. Check voltage to jet pump contactors
4. Verify that contactor coil(s) are getting the appropriate voltage when E-stop and timer are active

# SPA TROUBLE-SHOOTING GUIDE

---

## PROPULSION SYSTEM (CONT.)

### Light will not turn on

1. Verify that light switch is on
2. Verify that appropriate voltage is being supplied to light
3. Replace light

**NOTE** - Max. frequency setting *f/wave XP Pro*: 68 HZ.

## FILTRATION

### Filter pump will not turn on

1. Verify that E-stop is not tripped
2. Check voltage to filter pump contactor
3. Verify that contactor coil is getting the appropriate voltage when E-stop is active

### My chemicals are balanced (PH, TA, Sanitizer), but my water is cloudy

1. Shut down unit until problem is remedied and water is clear
2. Clean/replace filter
3. Review bather load and consult with pool professional

## SERVICEABLE COMPONENTS:

### Included serviceable components:

- G.F.C.I./Breaker Assembly
- E-stop
- Spring wound timer
- VFD
- Propulsion Motor
- Propulsion transmission system
- Belts
- Pulleys
- Bearing/hub assembly
- Propeller

### Optional serviceable components:

- Electrical control box
- Filter pump
- Jet pump 1
- Jet pump 2
- Light
- Filter
- Chlorinator

### Other possible serviceable components:

- Chemical maintenance system
- Heater
- Ozone Generator
- UV System
- Other water sanitization system

## CRITICAL REPLACEMENT COMPONENTS:

**WARNING** - *Items listed below shall only be replaced with identical components unless approved by Master Spas engineering department.*

- *Propulsion suction grate assembly: X804490*
- *Propulsion grate fasteners (4 per grate): X717900*
- *Propeller f/wave XP Pro: X400820*

## PROPULSION SUCTION GRATES MISC. SPECIFICATIONS:

- Maximum VFD frequency – 68Hz.
- Wall mount only
- Grate / frame assembly P/N – X804490
- Propulsion grate fastener P/N – X717900
- Propeller P/N –X400820
- Life span 7 years
- Tools required – No. 2 Phillips screwdriver
- Pulley system shall be 1:1 ratio only

**NOTE** - *Fitting and fasteners should be observed for damage or tampering before each use of the spa.*

## LIMITED WARRANTY

---

### **FIVE YEARS - SHELL STRUCTURE**

Master Spas, Inc. warrants to the original purchaser that the swim spa will not experience water loss from the swim spa due to defects in material or workmanship in the spa structure, for a period of five (5) years from the date of the original purchase. (Repair or replacement)

### **ONE YEAR - EQUIPMENT**

Master Spas Inc. warrants to the original purchaser that the E-stop timer, GFCI, and optional electrical control box will not malfunction due to defects in material and workmanship for a period of one (1) year from the date of the original purchase. (Parts and Labor)

### **THREE YEARS - SHELL SURFACE**

Master Spas, Inc. warrants to the original purchaser that the acrylic finish will not blister, crack or delaminate for a period of three (3) years from the date of original purchase as a result of defects in material or workmanship. (Repair or replacement)

### **THREE YEARS - PLUMBING**

Master Spas, Inc. warrants to the original purchaser for a period of three (3) years from the date of original purchase that the plumbing of the swim spa will remain free from leaks due to defects in material and workmanship (Parts and labor). Jet internals are warranted against malfunctions or defects due to defects in material and workmanship for period of (3) years from the date of original purchase (Parts only). The cost of shipping malfunctioning jet internals and installation of any replacement Jet internals is the sole responsibility of the purchaser.

### **TWO YEARS - WAVE PROPULSION SYSTEM**

Master Spas, Inc. warrants to the original purchaser the Wave Propulsion System (propeller drive and all associated components/mountings that operate such system including, but not limited to, the Wave control panel and motor) against malfunctions or defects in material and workmanship for a period of two (2) years from the date of the original purchase. (Parts and labor)

### **SKIRTING**

Master Spas, Inc. warrants to the original purchaser that the optional MasterSelect™ skirting will not crack or rip due to defects in material for a period of five (5) years from the date of the original purchase. Master Spas, Inc. warrants to the original purchaser that the DuraMaster Polymer™ skirting will not crack or rip for the life of the spa. Bowing (MasterSelect and DuraMaster) that can occur under some conditions is considered normal and is excluded under this limited warranty. The cost of shipping and installation of any replacement skirting is the sole responsibility of purchaser. (Parts only)

### **EXCLUSIONS**

This limited warranty is enforceable only by the original purchaser. Light bulbs, light lenses, fuses, covers, spa pillows or any non-factory installed accessories are specifically excluded from this limited warranty. Non-Factory installed accessories including but not limited to pumps, filters, and chlorine generators are covered by the original manufacturer's warranty, if any. In the event it is necessary to remove the swim spa from the premises to repair or replace any warrantable item, any and all cost of swim spa removal and replacement including but not limited to removal of the original swim spa and transportation of the replacement swim spa, damages to landscaping, decking, fencing or other structural alteration, or any cost related to obtaining access to the swim spa are the sole responsibility of the purchaser.

## LIMITED WARRANTY (CONT.)

---

### LIMITATIONS

This limited warranty does not apply to malfunctions if the swim spa has been subject to misuse, alteration or attempted alteration, repairs or attempted repairs by a non-approved service center or if a failure or malfunction is due to improper installation, improper water chemistry, improper maintenance, an act of God, weather conditions or other damage from causes beyond the control of Master Spas, Inc.. Misuse or abuse shall mean operation of the swim spa other than in conformity with the Master Spas, Inc. Owners Manual. Such misuse and abuse shall include but not be limited to the following:

- Damage of the swim spa surface caused by leaving the swim spa uncovered or due to covering the swim spa with plastic film of any kind.
- Damage to the swim spa surface caused by contact with unapproved cleaners or solvents.
- Damage caused by operation of the swim spa at water temperatures outside the range of 34° F - 104° F.
- Freeze damage
- Damage caused by unapproved sanitizers such as calcium, sodium hypochlorite, "tri-chlor" type chlorines or any sanitizing chemical that may remain un-dissolved on the swim spa surface.
- Damages or malfunction due to a dirty, clogged, calcified filters or use of an unapproved filter cartridge.
- Damages or malfunction caused by failure to provide even proper support for the swim spa.
- Damages or malfunction caused during installation of the swim spa.

### WARRANTY REGISTRATION

The original purchaser must, within ten (10) days from the date of the original purchase, register on line at [www.masterspas.com](http://www.masterspas.com). In the event of a warranty claim of a defect or malfunction covered under the provisions of this limited warranty, the original purchaser must first notify in writing the dealer who sold the swim spa within ten (10) days of the initial malfunction or discovery of defect. If the dealer does not provide service, then the purchaser should contact Master Spas, Inc. customer service department, via the web site, or provide written notice of the malfunction or defect at the address below. Within a reasonable time of receipt of the notice of the warranty claim, the Master Spas, Inc. dealer or an approved service center representative of Master Spas, Inc. will inspect the swim spa to determine if the malfunction or defect is a covered malfunction or defect under this limited warranty. If it is determined that the malfunction or defect is not covered by this limited warranty, the cost of the service call is the sole responsibility of the purchaser. If it is determined that the malfunction or defect is covered under this limited warranty, Master Spas, Inc. through its dealer, or approved service center representative will repair or replace the covered item. Master Spas, Inc. reserves the right for its dealers or approved service centers to collect from the original purchaser reasonable travel expenses. In addition, access charges will be assessed if the swim spa is not reasonably assessable for inspection, repair or replacement. This limited warranty is extended only to the original purchaser and is not transferable. This limited warranty becomes void upon the transfer of ownership of the swim spa or moving of the swim spa to a different location.

## LIMITED WARRANTY (CONT.)

---

### DISCLAIMERS

MASTER SPAS, INC. NEITHER ASSUMES NOR DO WE AUTHORIZE ANY OTHER PERSON TO ASSUME FOR US, ANY OTHER LIABILITY IN CONNECTION WITH THE SALE OF SPAS MANUFACTURED BY MASTER SPAS, INC. THIS LIMITED WARRANTY SHALL BE THE EXCLUSIVE REMEDY AVAILABLE TO A PURCHASER AND MASTER SPAS, INC. SHALL NOT BE LIABLE FOR ANY INCIDENTAL OR CONSEQUENTIAL DAMAGES RESULTING FROM MISUSE OF THE SWIM SPA OR CAUSED BY ANY DEFECT, FAILURE OR MALFUNCTION OF THE SWIM SPA, WHETHER A CLAIM IS BASED UPON WARRANTY, CONTRACT, NEGLIGENCE OR OTHERWISE. SOME STATES DO NOT ALLOW THE EXCLUSION OF INCIDENTAL OR CONSEQUENTIAL DAMAGES, SO THIS LIMITATION MAY NOT APPLY TO YOU.

TO THE EXTENT PERMITTED BY APPLICABLE LAW, THIS LIMITED WARRANTY SPECIFICALLY EXCLUDES ANY AND ALL IMPLIED WARRANTIES OF MERCHANTABILITY AND/OR FITNESS FOR A PARTICULAR PURPOSE, OTHERWISE ALL IMPLIED WARRANTIES

ARE LIMITED IN DURATION TO TWO (2) YEARS FROM THE ORIGINAL DATE OF PURCHASE. SOME STATES DO NOT ALLOW THE LIMITATION OF THE DURATION OF IMPLIED WARRANTIES, SO THIS LIMITATION MAY NOT APPLY TO YOU. THERE ARE NO OTHER WARRANTIES, EITHER EXPRESSED OR IMPLIED, OF ANY KIND OR NATURE WHICH EXTEND BEYOND THE DESCRIPTION ON THE FACE HEREOF.

Manufactured By  
Master Spas, Inc.  
6927 Lincoln Parkway  
Fort Wayne IN 46804  
260.436.9100 • 800-860-7727  
[www.masterspas.com](http://www.masterspas.com)

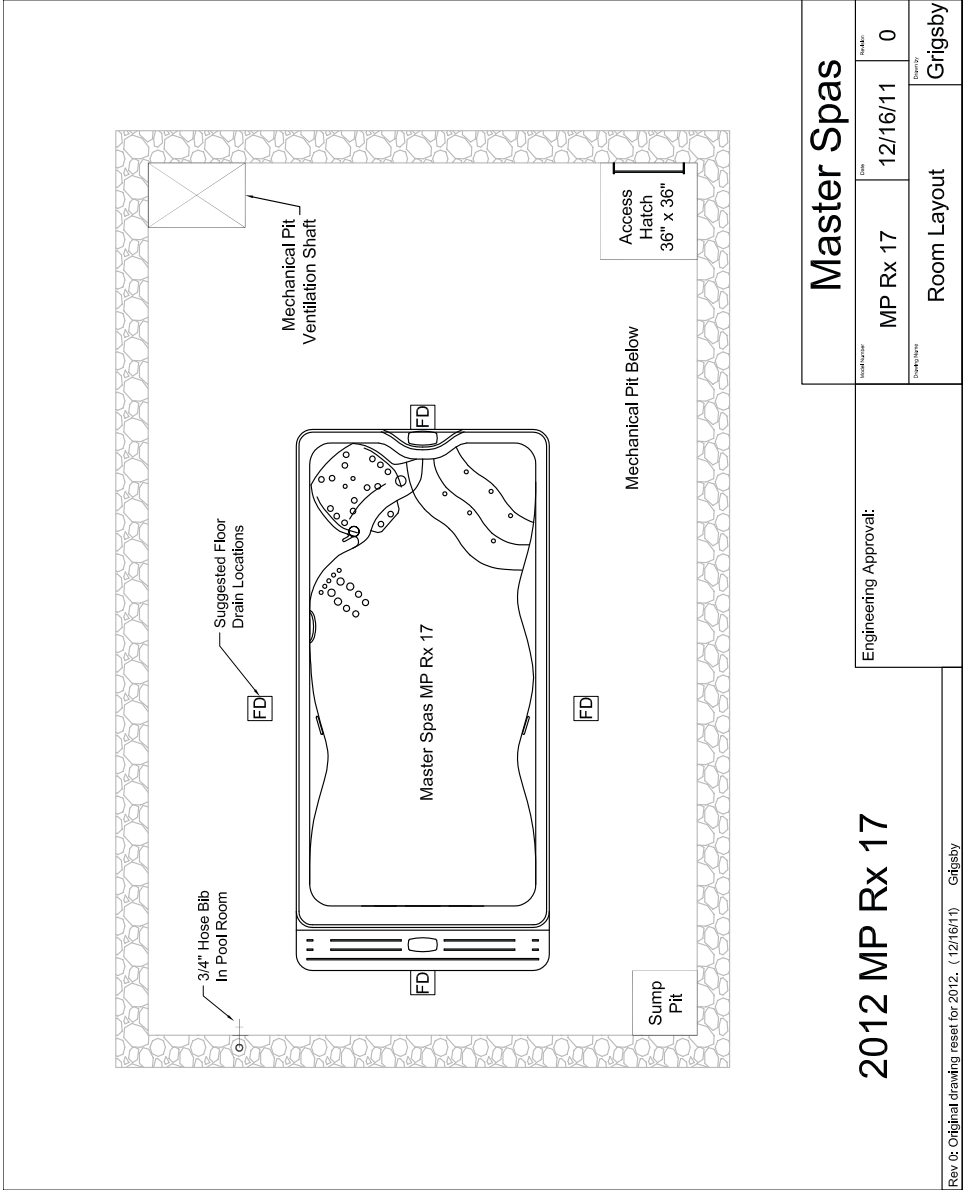

<b>Master Spas</b>	
Model Number <b>MP Rx 17</b>	Date <b>12/16/11</b>
Scale <b>0</b>	Drawn By <b>Grigsby</b>
<b>Room Layout</b>	

Engineering Approval:

# 2012 MP Rx 17

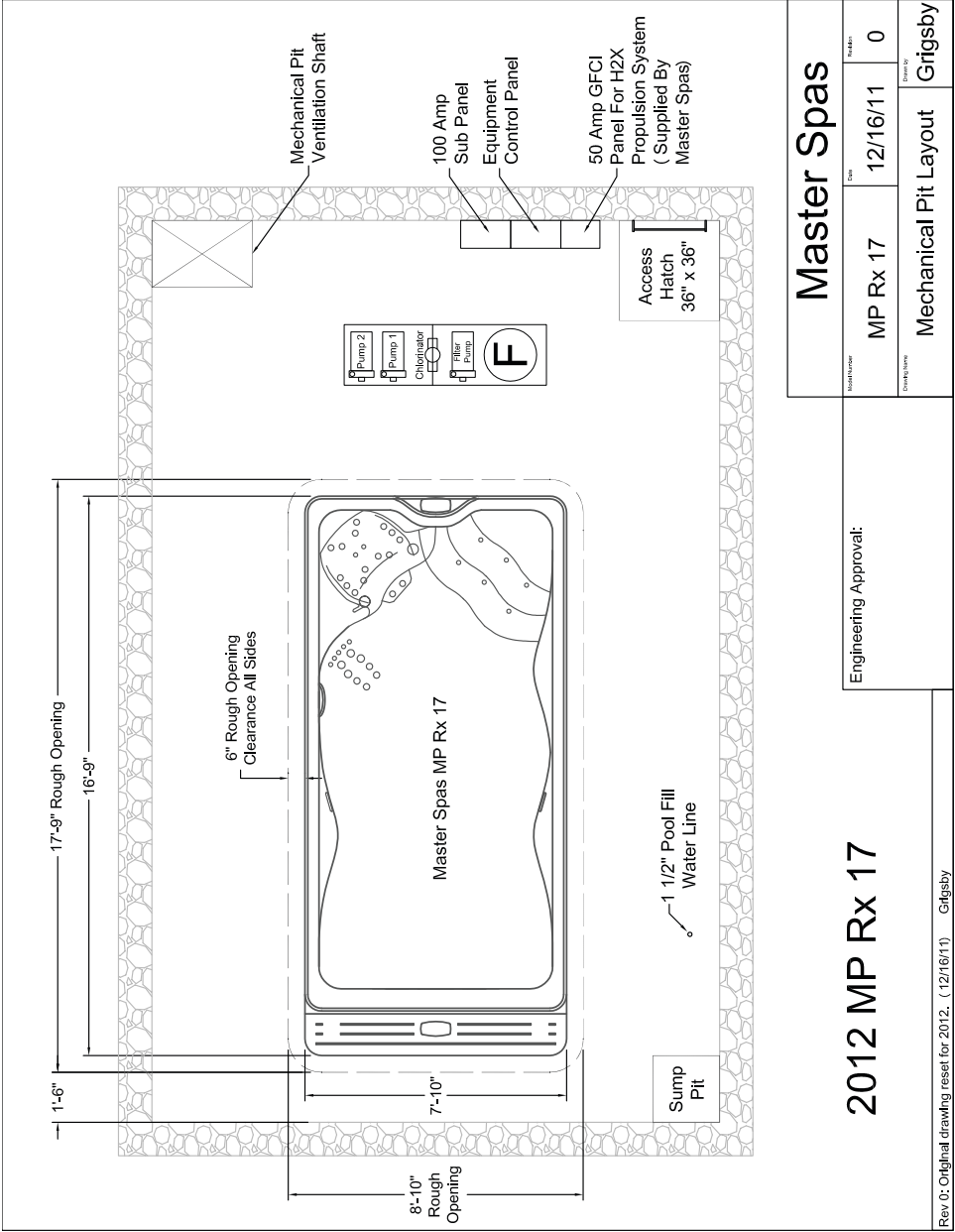

# 2012 MP Rx 17

Engineering Approval:

## Master Spas

Model Number	MP Rx 17	Date	12/16/11	Revision	0
Drawn By	Mechanical Pit Layout				
Checked By	Grigsby				

Rev 0: Original drawing reset for 2012. (12/16/11) Grigsby

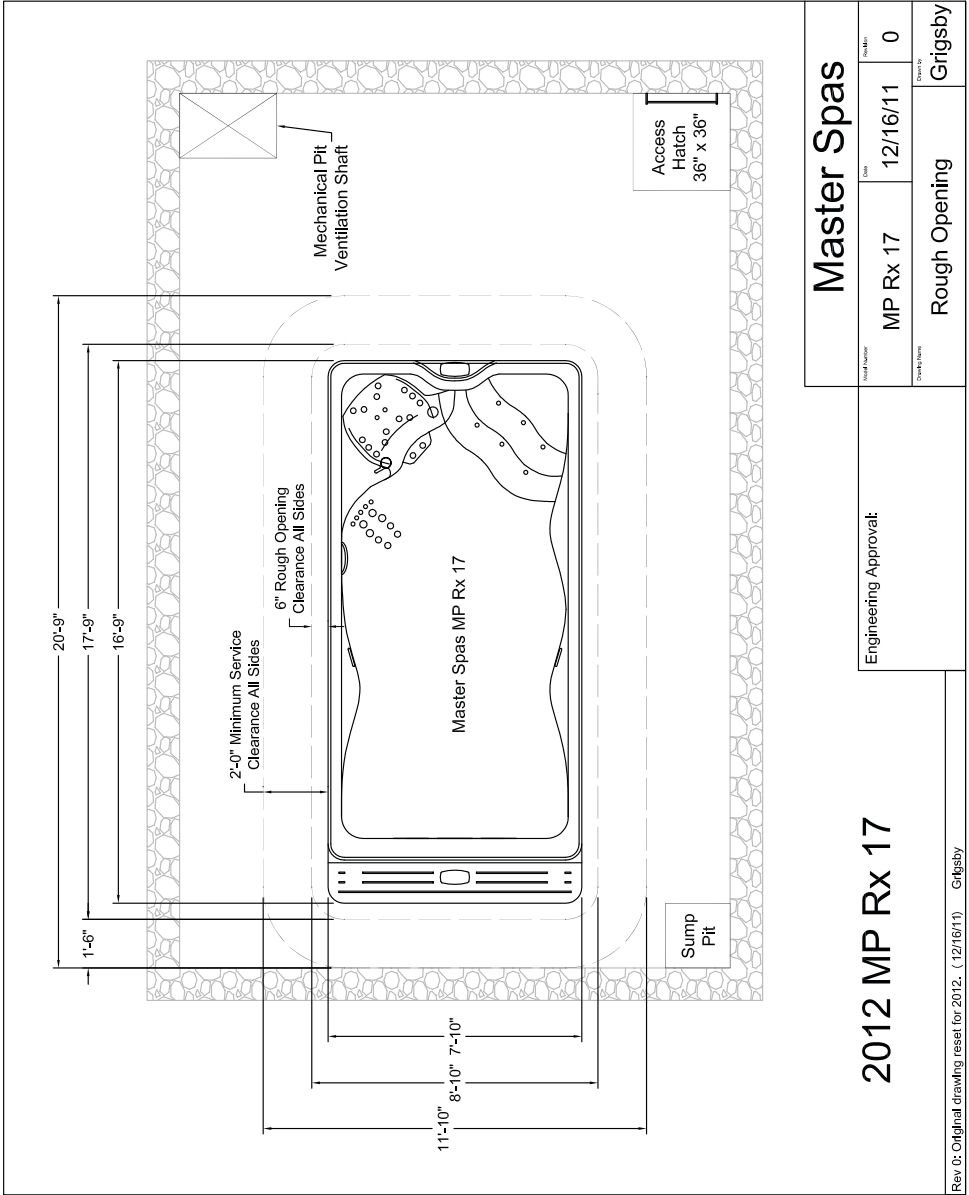

<b>Master Spas</b>	
Model Number	MP Rx 17
Date	12/16/11
Sheet No.	0
Drawn By	Grigsby
<b>Rough Opening</b>	

Engineering Approval:

**2012 MP Rx 17**

Rev. 0: Original drawing reset for 2012. (12/16/11) Grigsby



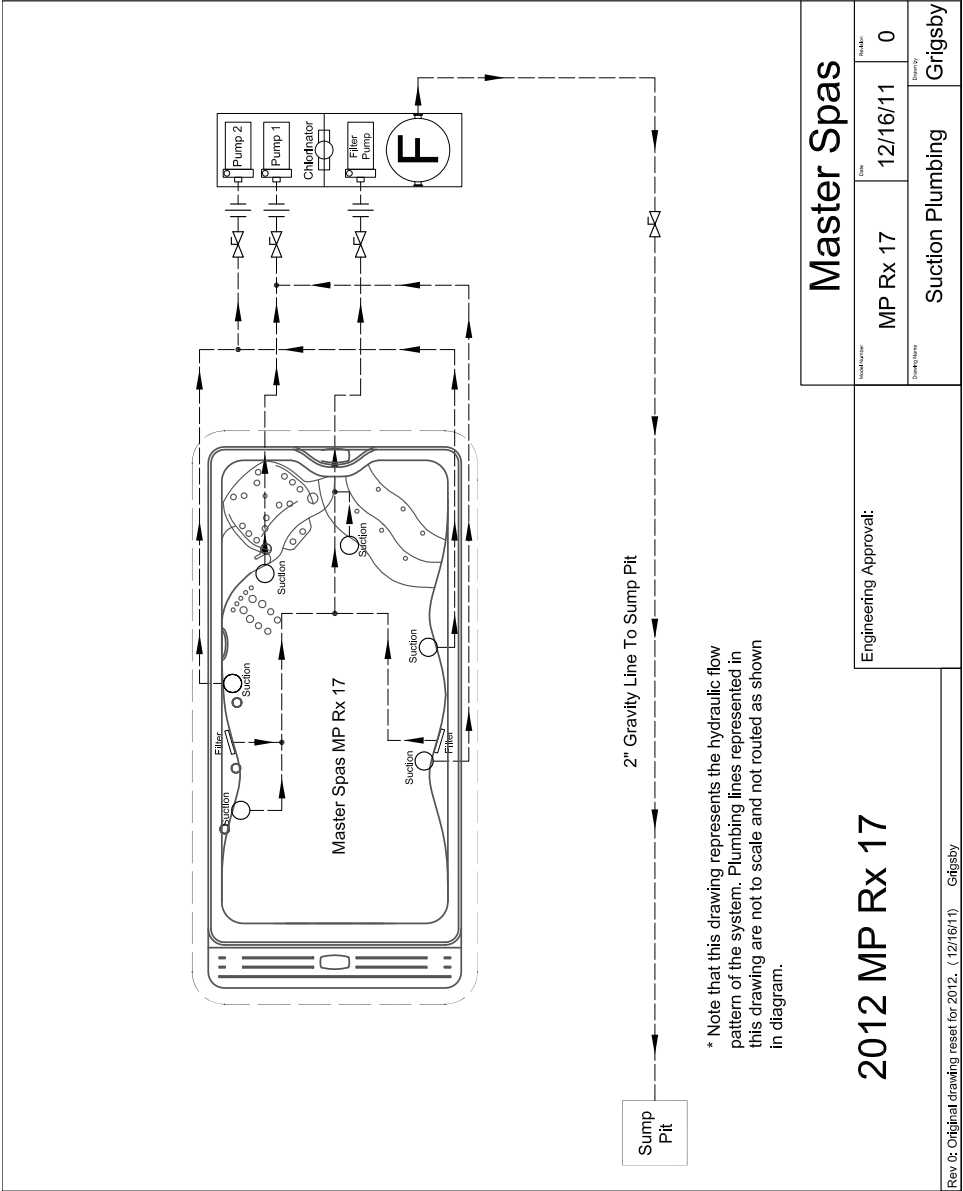

2" Gravity Line To Sump Pit

\* Note that this drawing represents the hydraulic flow pattern of the system. Plumbing lines represented in this drawing are not to scale and not routed as shown in diagram.

# 2012 MP Rx 17

Engineering Approval:

<b>Master Spas</b>	
Model Number	MP Rx 17
Date	12/16/11
Scale	0
Drawn By	Suction Plumbing
Checked By	Grigsby

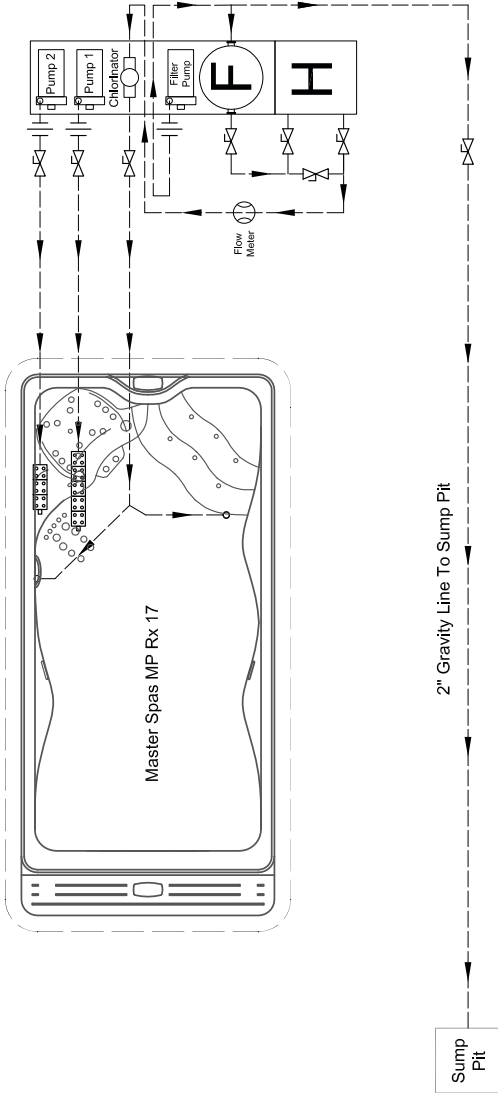

\* Note that this drawing represents the hydraulic flow pattern of the system. Plumbing lines represented in this drawing are not to scale and not routed as shown in diagram.

# 2012 MP Rx 17

Engineering Approval:

<b>Master Spas</b>	
Model Name	MP Rx 17
Date	12/16/11
Sheet No.	0
Drawn By	Grigsby
Return Plumbing	

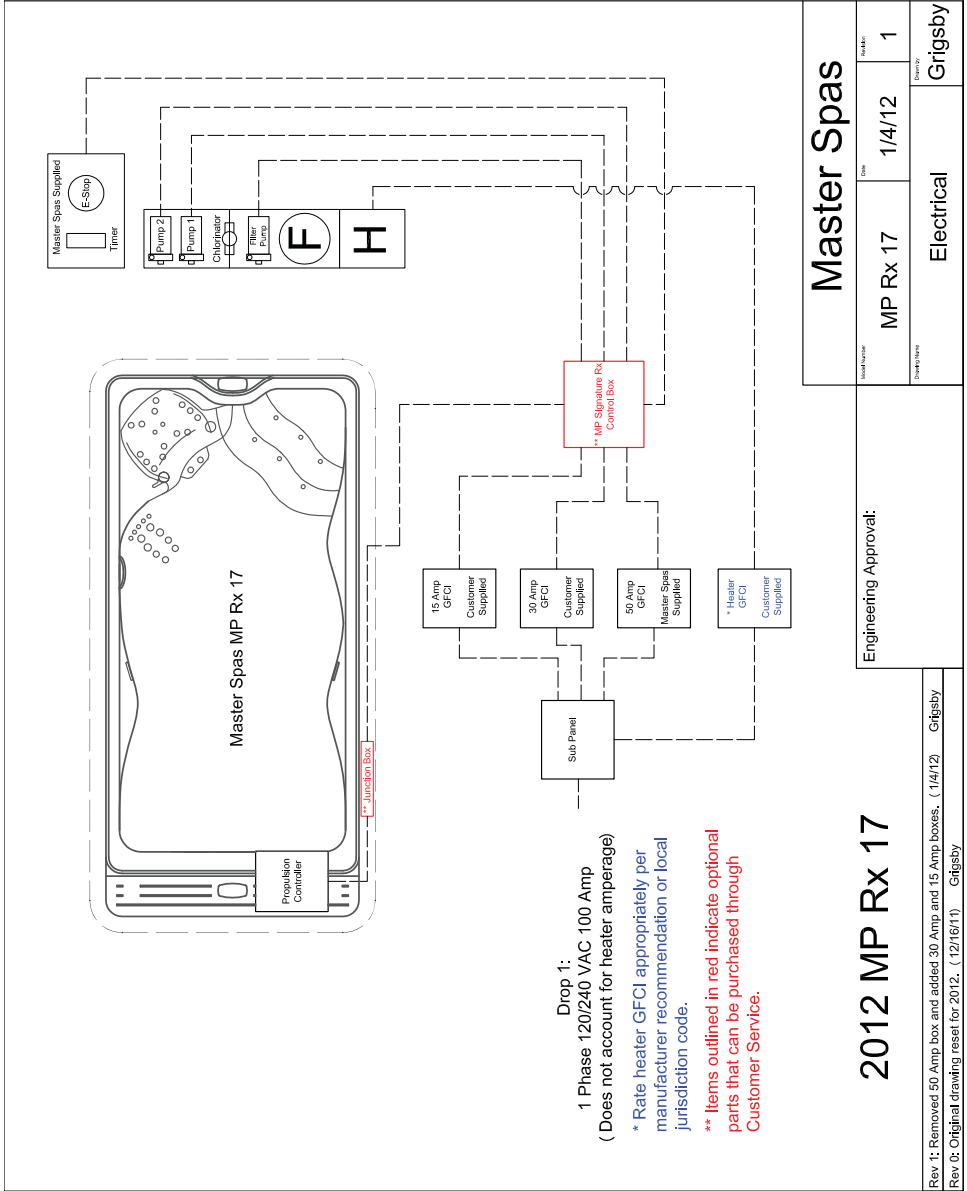

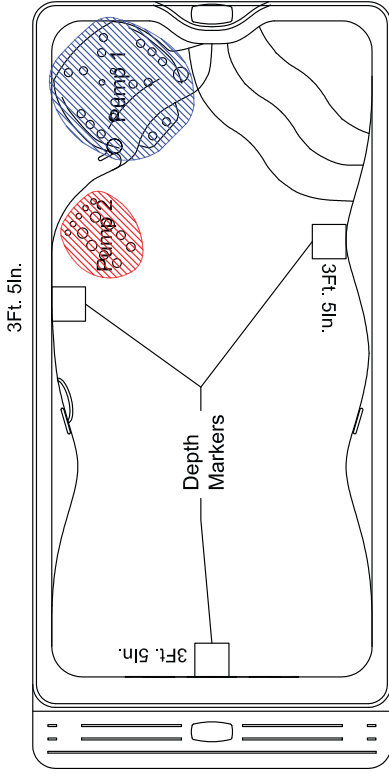

# 2012 MP Rx 17

# Master Spas

Engineering Approval:		Model Number	Date	Serial
		MP Rx 17	12/16/11	0
Controls			Company	Grigsby

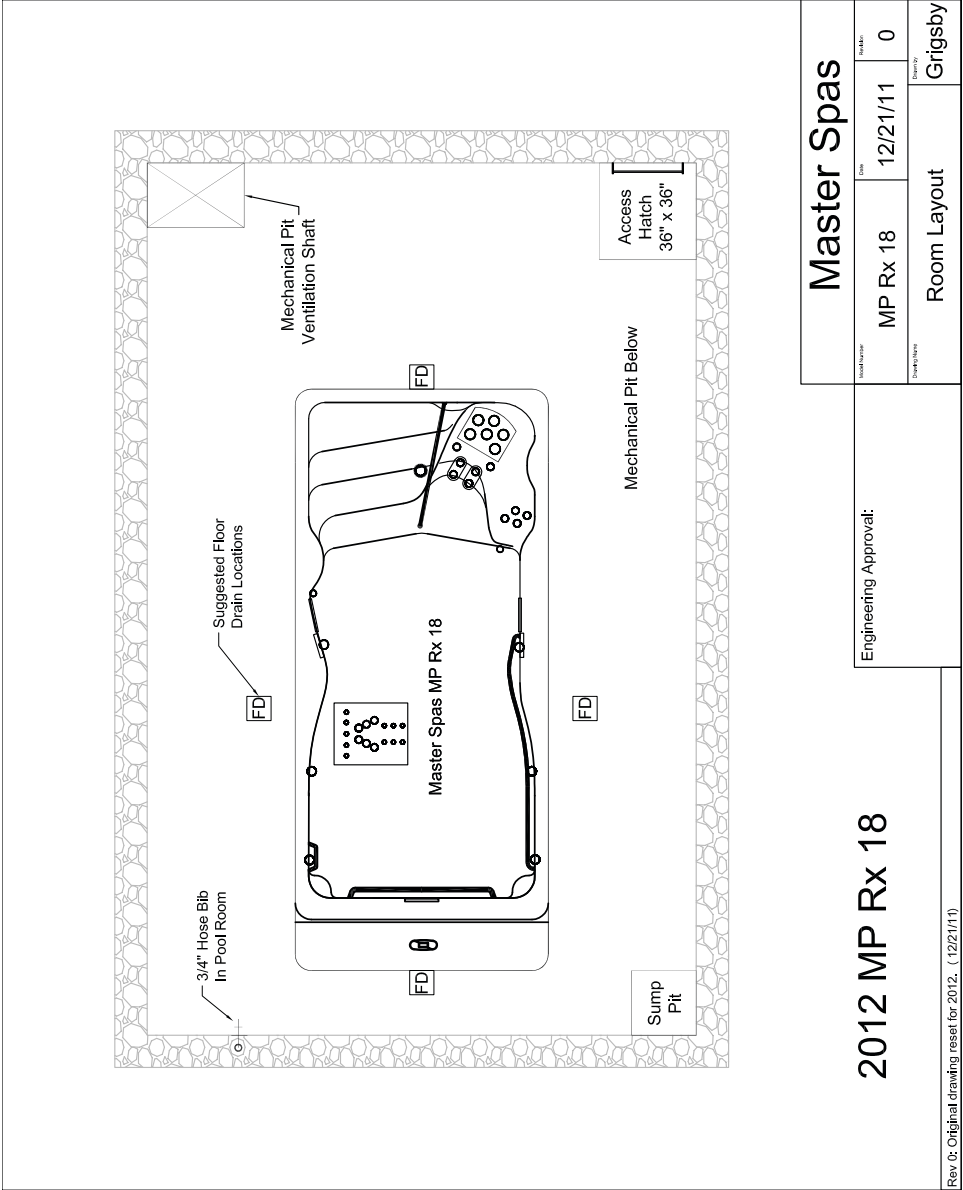

<b>Master Spas</b>		
Model Number	Date	Scale
MP Rx 18	12/21/11	0
Room Layout		Drawn By
		Grigsby

Engineering Approval:

## 2012 MP Rx 18

Rev. 0: Original drawing reset for 2012. (12/21/11)

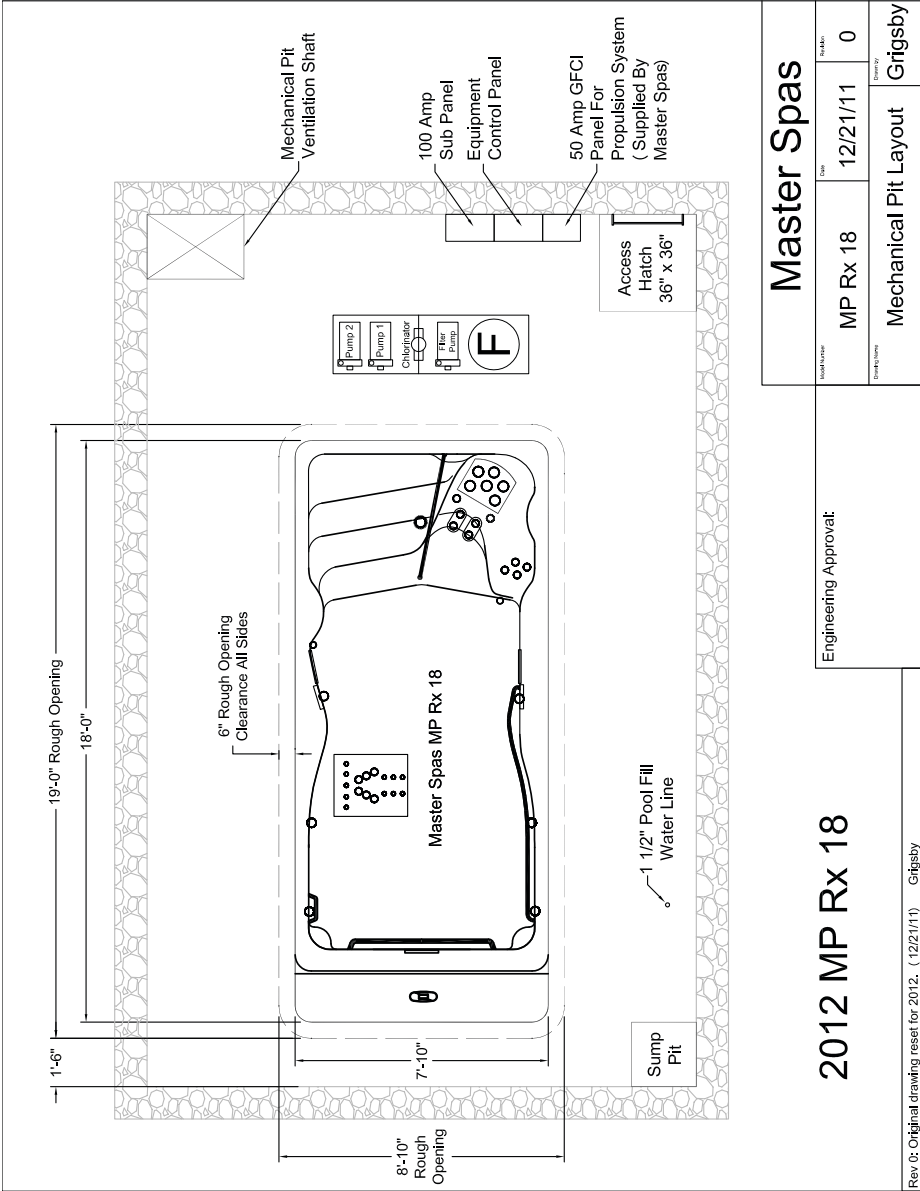

<b>Master Spas</b>	
Model Number	MP Rx 18
Date	12/21/11
Sheet No.	0
Drawn By	Grigsby
<b>Mechanical Pit Layout</b>	

Engineering Approval:

**2012 MP Rx 18**

Rev 0: Original drawing reset for 2012. (12/21/11) Grigsby

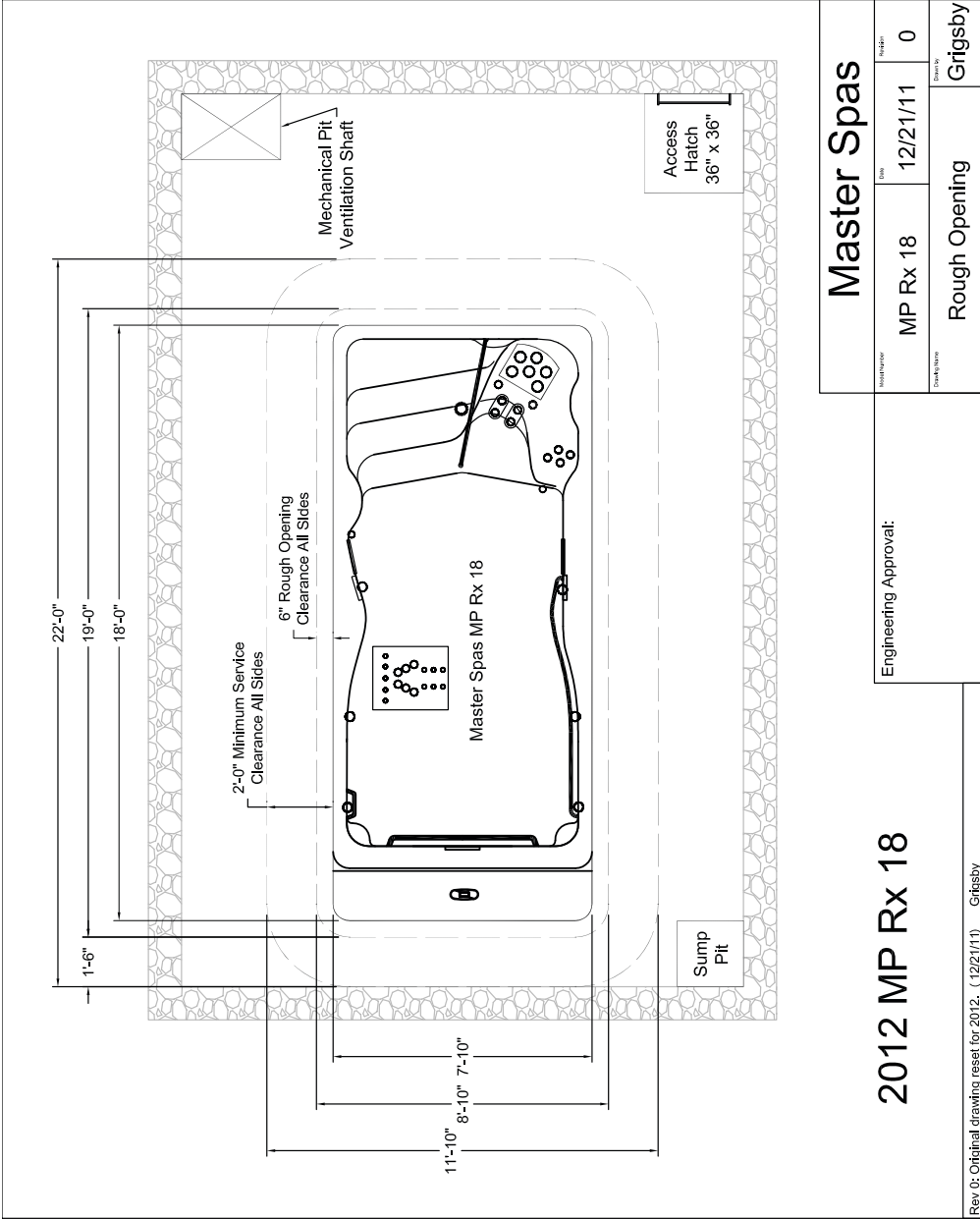

Engineering Approval:

<b>Master Spas</b>	
Model Number <b>MP Rx 18</b>	Date <b>12/21/11</b>
Date of Issue <b>Rough Opening</b>	Revision <b>0</b>
Drawn By <b>Grigsby</b>	

# 2012 MP Rx 18

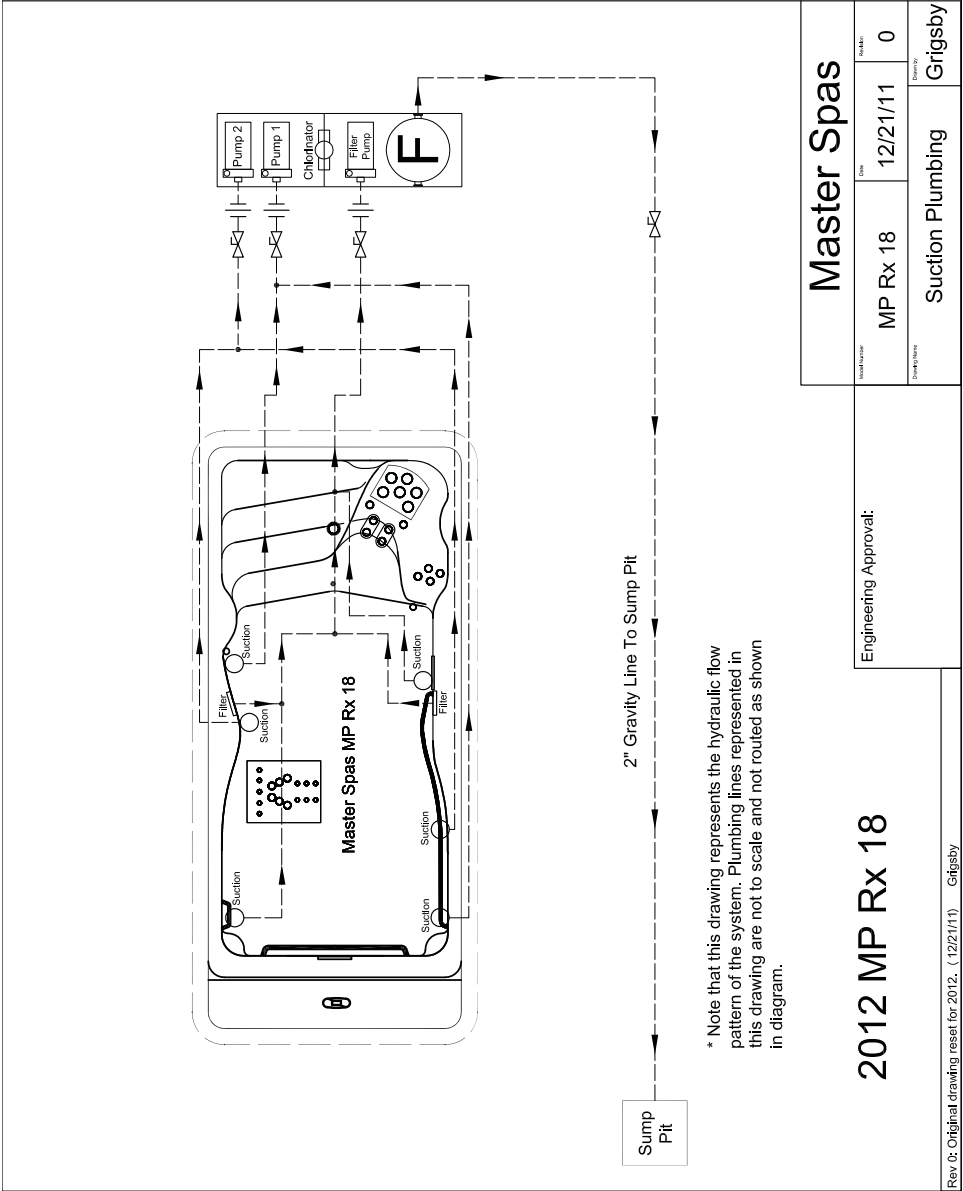

\* Note that this drawing represents the hydraulic flow pattern of the system. Plumbing lines represented in this drawing are not to scale and not routed as shown in diagram.

# 2012 MP Rx 18

Engineering Approval:

<b>Master Spas</b>	
Model Number	MP Rx 18
Date	12/21/11
Scale	0
Drawn By	Suction Plumbing
Checked By	Grigsby



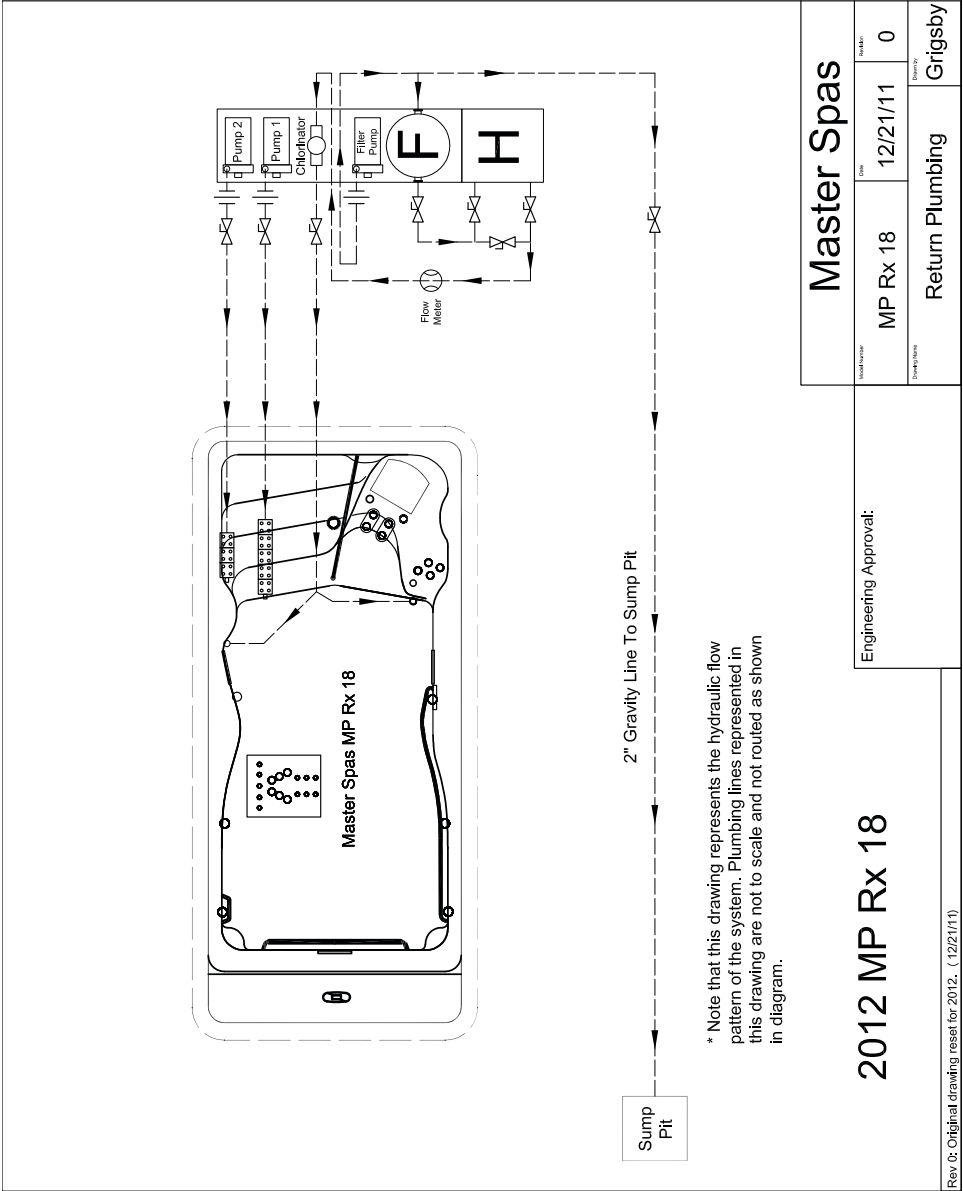

\* Note that this drawing represents the hydraulic flow pattern of the system. Plumbing lines represented in this drawing are not to scale and not routed as shown in diagram.

<b>Master Spas</b>	
Model Number	MP Rx 18
Date	12/21/11
Scale	0
Drawn By	Return Plumbing
Checked By	Grigsby

Engineering Approval:

## 2012 MP Rx 18

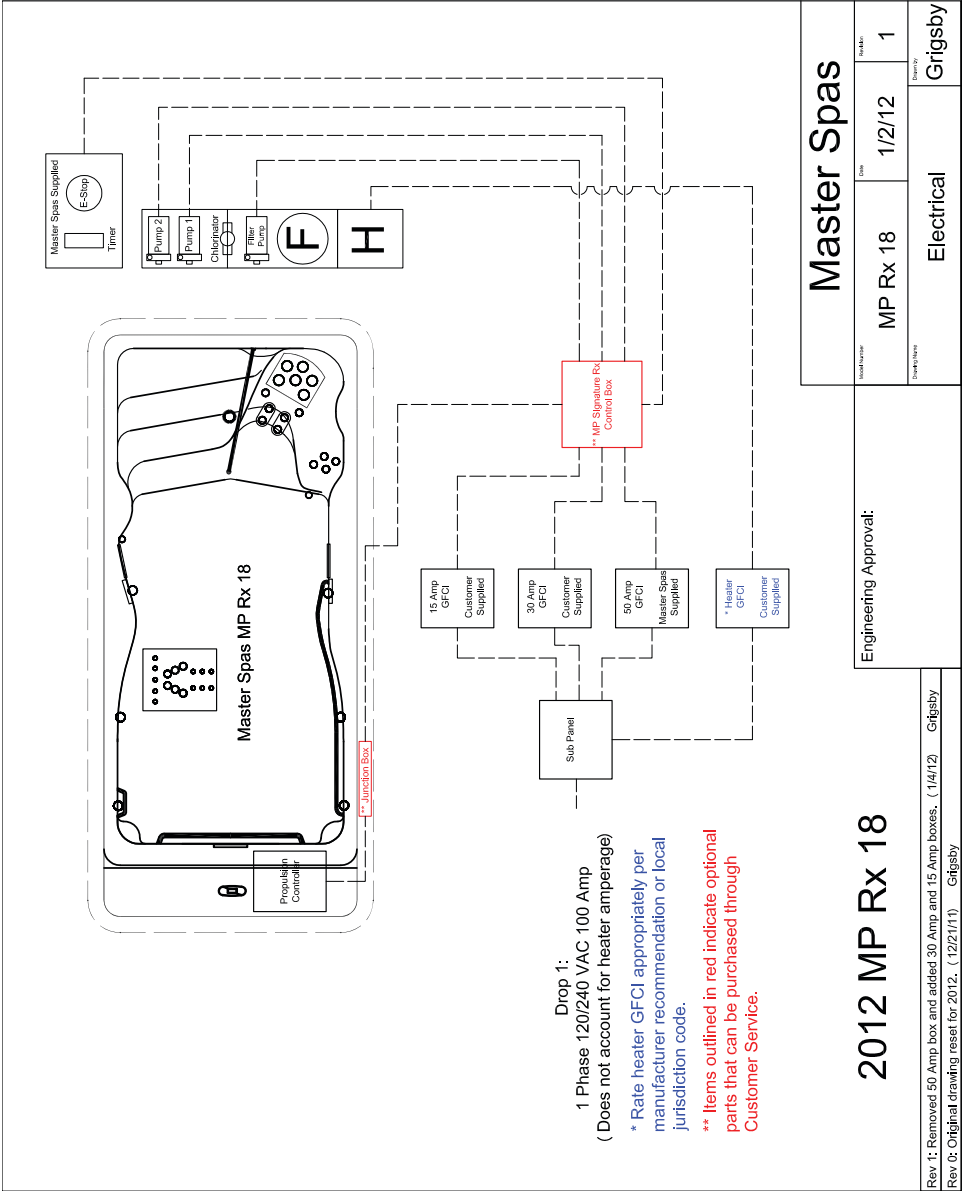

- Drop 1:
- 1 Phase 120/240 VAC 100 Amp  
( Does not account for heater amperage)
- \* Rate heater GFCI appropriately per manufacturer recommendation or local jurisdiction code.
- \*\* Items outlined in red indicate optional parts that can be purchased through Customer Service.

Engineering Approval:

<b>Master Spas</b>	
Model Number	MP Rx 18
Date	1/2/12
Scale	1
Drawn By	Electrical
Checked By	Grigsby

## 2012 MP Rx 18

Rev 1: Removed 50 Amp box and added 30 Amp and 15 Amp boxes. (1/4/12) Grigsby  
 Rev 0: Original drawing reset for 2012. (12/21/11) Grigsby

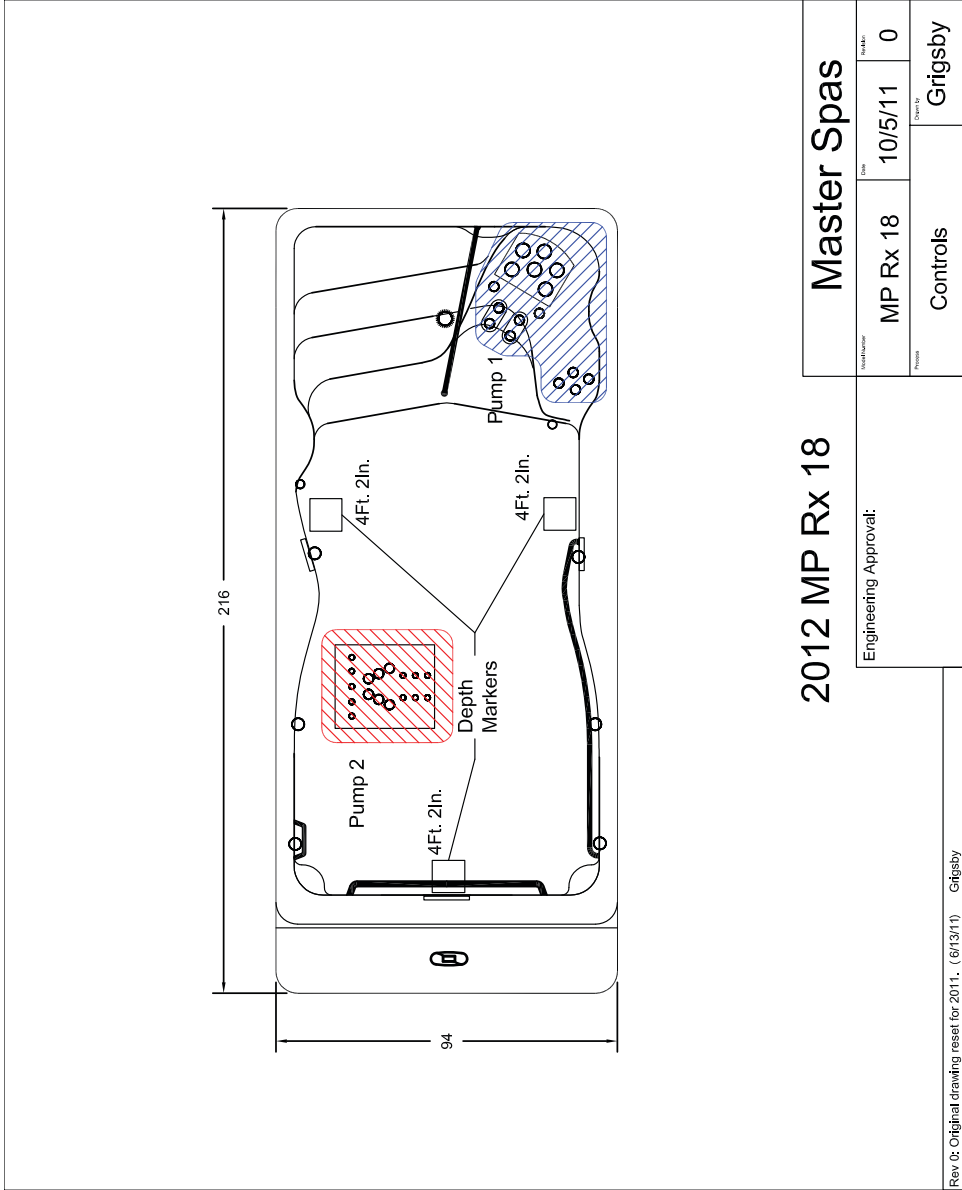

# 2012 MP Rx 18

## Master Spas

Model Number	MP Rx 18	Date	10/5/11	Scale	0
Project	Controls			Designer	Grigsby

Engineering Approval:

14" L x 12 1/2" H x 6" D - Main Box (1/2)  
 9" L x 8 1/2" H x 6" D - Secondary Box (2/2)

CIRCUIT PROTECTED BY A CLASS A GFCI (PROVIDED).  
 USE COPPER CONDUCTOR ONLY.  
 #6 AWG MIN. WIRE = 75° EMPLOYER UNDERTAKING RES. FOR ALL ELECTRICAL CONNECTIONS. USE CONDUCTORS SIZED ON THE BASIS OF 60°C AMPACITY BUT RATED NUMBER OF 75°C.

NOTE:  
 COMMERCIAL ELECTRICAL BOX 1 OF 2 (OPTIONAL)

**WARNING**  
 DO NOT USE ADDITIONAL POWER SOURCES FOR THE INVERTER. LEADS FOR ADDITIONAL POWER MUST BE PROTECTED BY A CLASS A GFCI (PROVIDED).  
 LEADS FOR ADDITIONAL POWER SOURCES FOR THE INVERTER MUST BE PROTECTED BY A CLASS A GFCI (PROVIDED).

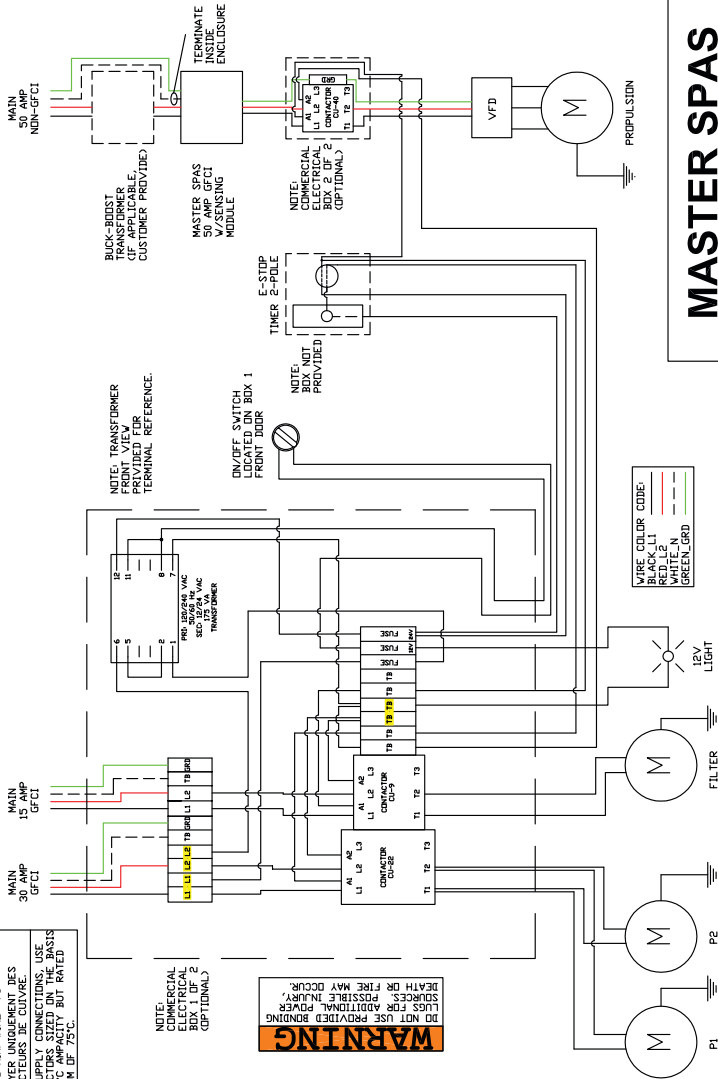

# MASTER SPAS

ENGINEERING APPROVAL:	MODEL NUMBER:	DATE:	REV:
	COMMERCIAL MP	12/22/11	0
	PROCESS:		DRAWN BY:
	ELECTRICAL DIAGRAM		KENCHANH

REV 0: Original drawing reset for 2012. (12/22/11)

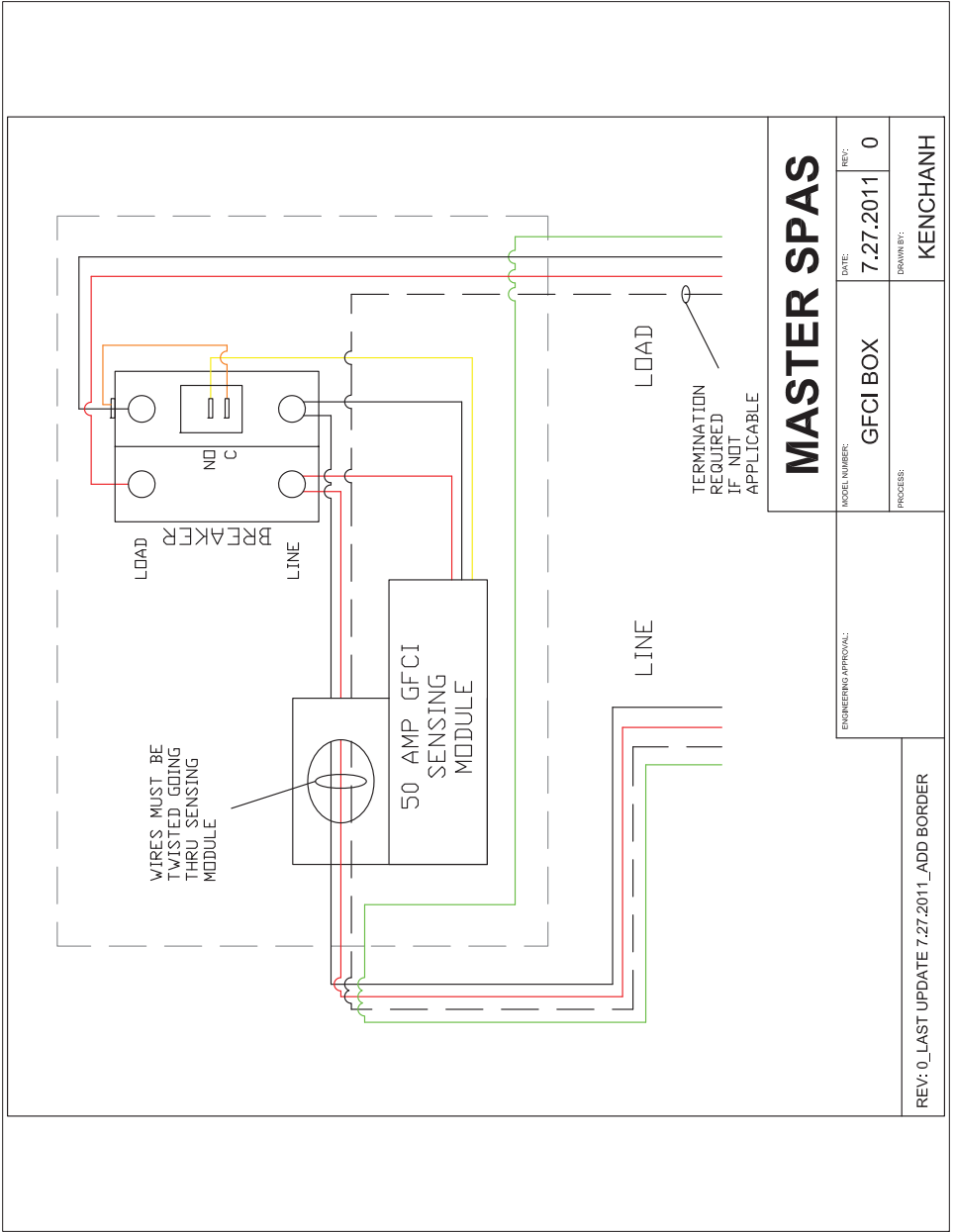

<b>MASTER SPAS</b>	
MODEL NUMBER:	DATE:
GFCI BOX	7.27.2011
PROCESS:	REV:
	0
DRAWN BY:	
KENCHANH	

ENGINEERING APPROVAL:

REV: 0\_LAST UPDATE 7.27.2011\_ADD BORDER

LINE  
3-PHASE  
208VAC

BUCK-BOOST  
MODEL 80-MN040

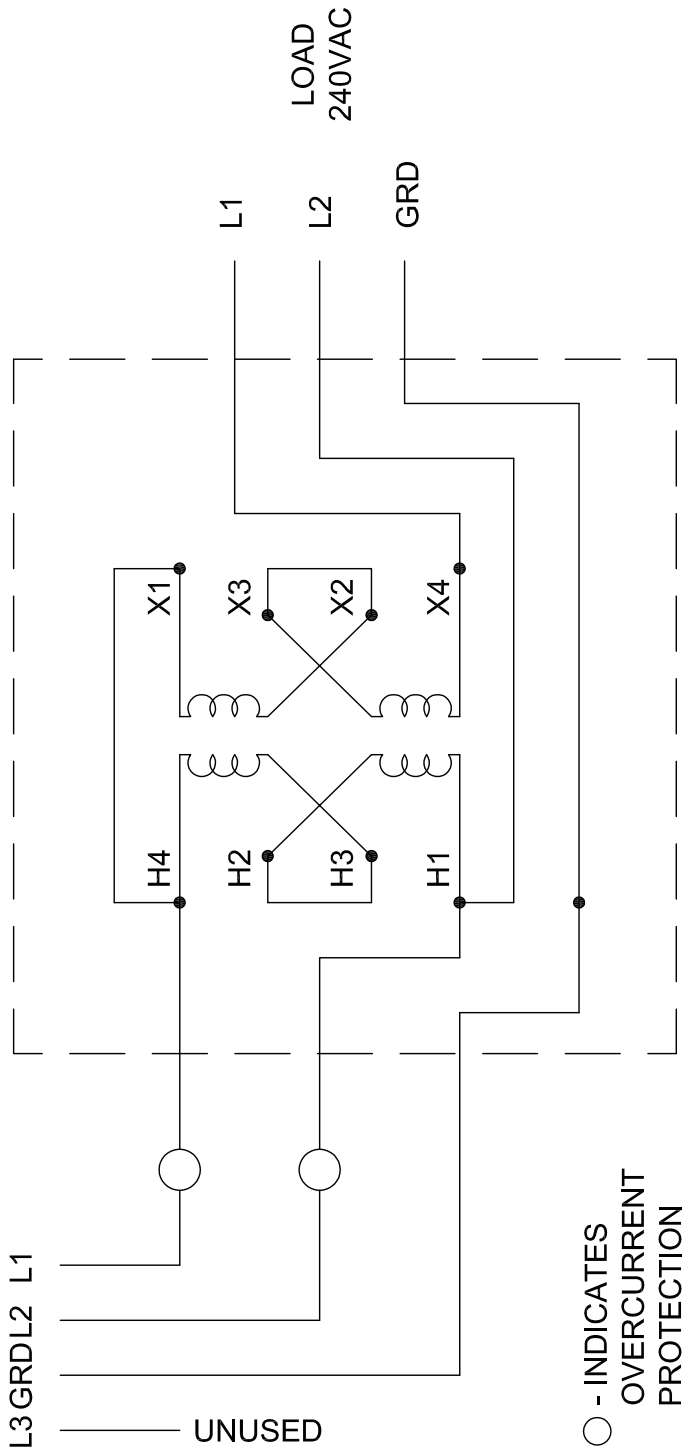

○ - INDICATES  
OVERCURRENT  
PROTECTION

**RECOMMENDED JET PUMP 2**

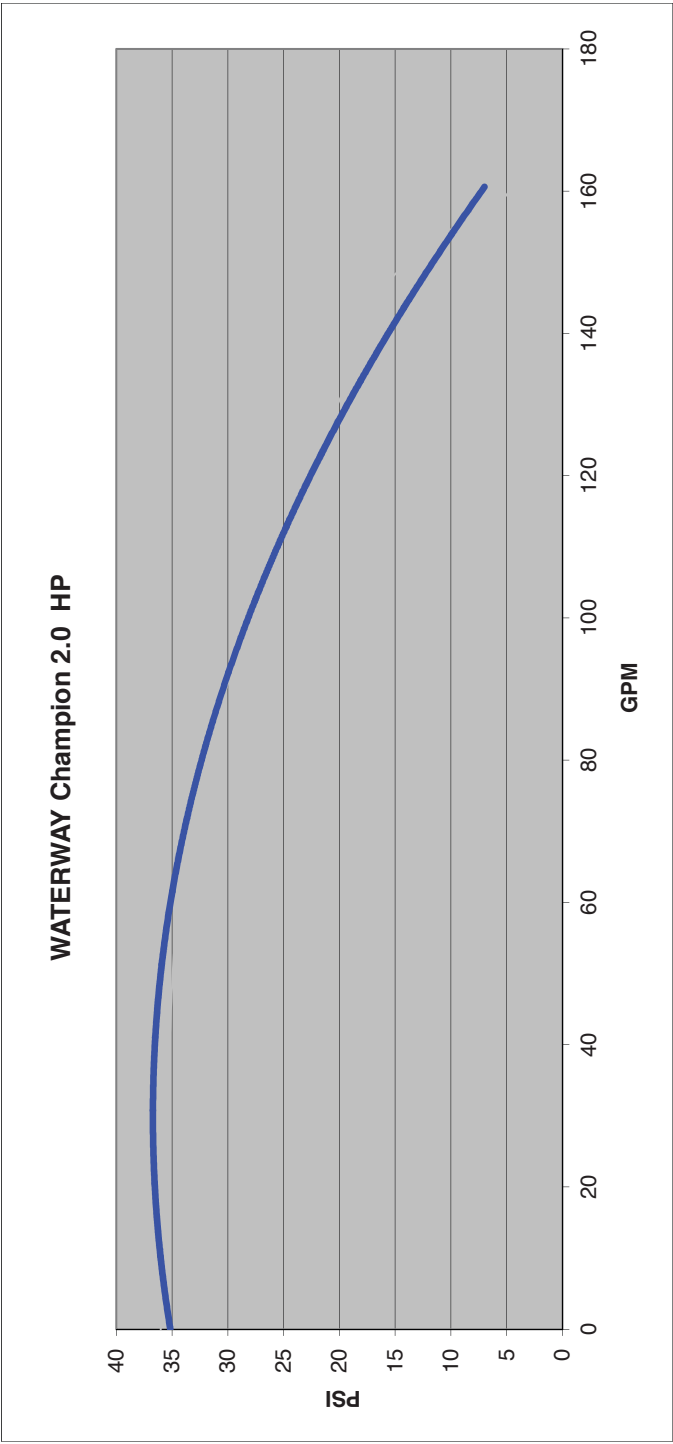

Pump curve supplied for installers where recommended pump is used.

**RECOMMENDED JET PUMP 1, FILTER PUMP**

**WATERWAY Champion 1.5 HP**

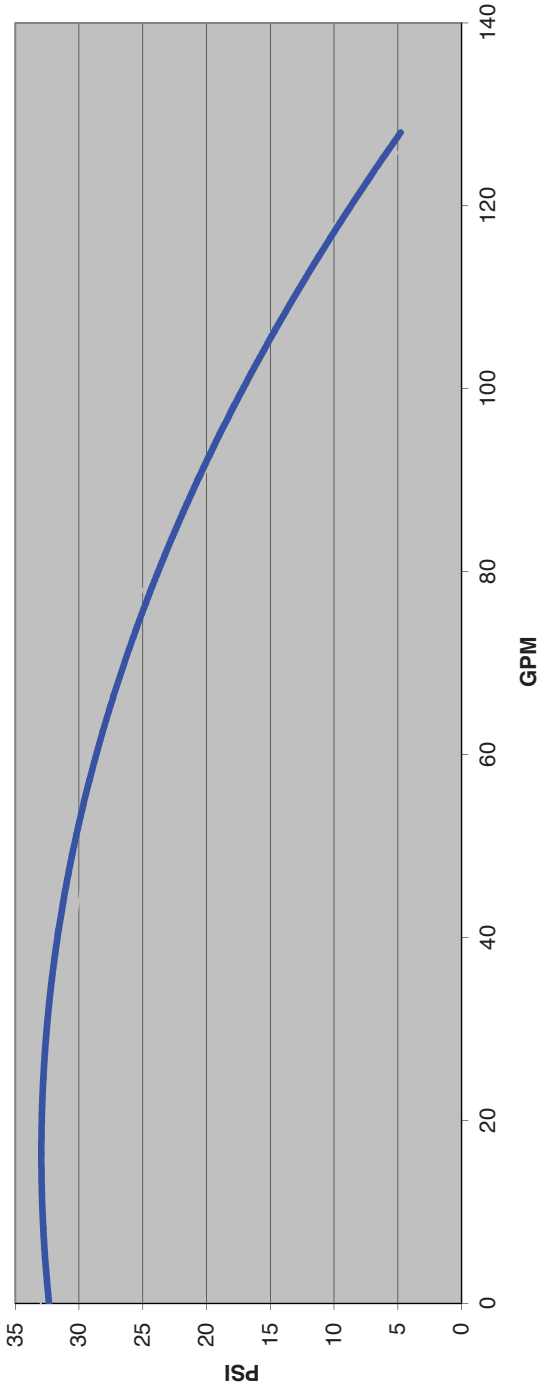











## OWNER'S MANUAL

Manufactured by Master Spas,  
one of the world's leading spa manufacturers.

6927 Lincoln Parkway  
Fort Wayne, IN 46804  
800.860.7727

**The manufacturer reserves the right to change specifications or features without notice.** As a manufacturer of spas and related products we stand behind every product we produce pursuant to those representations which are stated in our written limited warranty. Your dealer is an independent business person or company and not an employee or agent of the manufacturer. We cannot and do not accept any responsibility or liability for any other representations, statements or contracts made by any dealer beyond the provisions of our written limited warranty.

Rev 09/2012